

**INDUSTRIA GRANITO, CERÁMICA Y CUARZO**  
**GRANITE, CERAMIC & QUARTZ INDUSTRY**



**TOOLS**

**CHEMICALS**

**MASTICS & RESINS**

**ABRASIVOS**  
**ALICANTE**  
*Innovation in the service of Surfaces*







# INDEX

## SOBRE NOSOTROS

ABOUT US

**INTRODUCCIÓN**  
INTRODUCTION 006

**CIFRAS**  
NUMBERS 007

**HISTORIA**  
HISTORY 008

**CALIDAD**  
QUALITY 012

**FILOSOFÍA**  
PHILOSOPHY 013

**INNOVACIÓN**  
INNOVATION 014

**ÚTILES**  
TOOLS 022

**FICKERT** 024

**75MM  
180M** 032

**200MM  
900MM** 036

**QUÍMICOS**  
CHEMICALS 040

**MASILLAS & RESINAS**  
MASTICS & RESINS 044

**NOMENCLATURA**  
NOMENCLATURE 47



## YOUR MANUFACTURE PARTNER FOR NATURAL STONE, TERRAZZO, CERAMIC, QUARTZ & CONCRETE



**Abrasivos Alicante**, avalada por más de 25 años de experiencia, es una empresa española líder en fabricación de herramientas y productos químicos destinados al procesado y tratamiento de Mármol, Granito, Terrazo, Cerámica, Cuarzo y Hormigón.

Gracias a nuestro personal altamente cualificado y experimentado, damos soluciones innovadoras, mejorando los procesos productivos de nuestros clientes. Asimismo, el departamento de I+D+i junto con un "feed back" continuo de nuestros socios-clientes, hace que actualmente podamos ofrecer la gama de productos más extensa del mercado, consiguiendo unas prestaciones excepcionales.

Además, todos estos procesos de investigación, producción y atención al cliente están avalados y certificados con la norma ISO:9001:2015.

Desde nuestros inicios hemos experimentado un incesante crecimiento internacional. Presentes en más de 90 países, continuamos en busca de nuevas oportunidades y socios comerciales, que nos permita llevar nuestras soluciones y tecnologías a todo el mundo.

*Abrasivos Alicante, backed by over 25 years of experience, is a Spanish company, leader in the manufacturing of tools and chemicals for the processing and treatment of Marble, Granite, Terrazzo, Ceramic, Quartz and Concrete.*

*Thanks to our highly qualified and experienced staff, we provide innovative solutions, improving the production processes of our customers. Likewise, the R+D+i department, along with a continuous feed-back from our partners-customers, allows us now to offer the widest range of products on the market, achieving exceptional performance.*

*In addition, all these research processes, production and customer service are endorsed and certified with the ISO: 9001:2015.*

*Since our beginnings we have experienced an unceasing international growth. Present in more than 90 countries, we continue to look for new opportunities and business partners, allowing us to share our solutions and technologies worldwide.*

ABRASIVOS  
ALICANTE

# EN CIFRAS

## IN NUMBERS

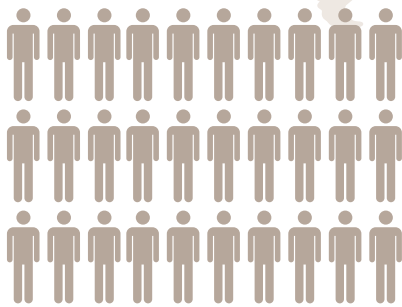

**MAS DE 2000  
CLIENTES  
SATISFECHOS**

*MORE THAN 2000  
SATISFIED  
CUSTOMERS*



**3 CENTROS  
PRODUCTIVOS**

*3 PRODUCTION  
CENTERS*



**VENDEMOS EN MÁS  
DE 90 PAÍSES**

*SALES IN MORE THAN  
90 COUNTRIES*

**MÁS DE 25 AÑOS  
DE EXPERIENCIA**

*MORE THAN 25  
YEARS OF EXPERIENCE*



**MILES DE PRODUCTOS  
EN STOCK**

*THOUSANDS OF PRODUCTS  
IN STOCK*



**75% DE LOS PEDIDOS  
SERVIDOS EN 24 HORAS**

*75% OF THE ORDERS  
DELIVERED IN 24 HOURS*



**FABRICAMOS MÁS DE  
10.000 REFERENCIAS.**

*WE MANUFACTURE MORE THAN  
10,000 REFERENCES.*

**PRODUCCIÓN DIARIA:  
+5000 PRODUCTOS**

*DAILY PRODUCTION:  
+5000 PRODUCTS*

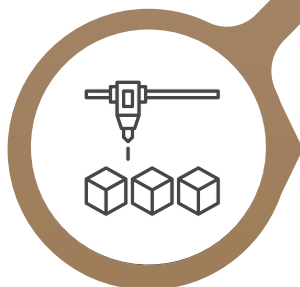

# HISTORIA

HISTORY

1993

## EL ORIGEN THE BEGINNING

Creación de la compañía **Abrasivos Alicante** e inicio de la producción con la primera familia de productos **ABRILLANTADORES 5 EXTRA**, desarrollando para ello la tecnología **ROBOT** e **HYDRODINAMIC**.

*Creation of the company **Abrasivos Alicante** and beginning of production with the first family of **BRIGHTNERS 5 EXTRA** developing the **ROBOT** and **HYDRODINAMIC** technology.*

— TECHNOLOGIES ▼

**HYDR**DYNAMIC **ROBOT**  
MULTI-PRESS



1996

Finalización del desarrollo y comienzo de la producción de **ABRASIVOS SYNTEX** y de **RESINA**.

INICIO DE LA **EXPANSIÓN INTERNACIONAL**.

*Completion of the development and start of production of **SYNTEX** and **RESIN ABRASIVES**.*

*BEGINNING OF **INTERNATIONAL EXPANSION**.*

— TECHNOLOGIES ▼

**SYNTEX**<sup>®</sup>  
FORMULA

**RESIN**<sup>®</sup>  
FORMULA



2005

Nueva familia de productos **ABRASIVOS DIAMANTADOS METÁLICOS (ADM)**.

*New family of products **DIAMOND METALLIC ABRASIVES (ADM)**.*

— TECHNOLOGIES ▼

**ADM**<sup>®</sup> **Basic**<sup>®</sup>

**PLUS**<sup>®</sup>

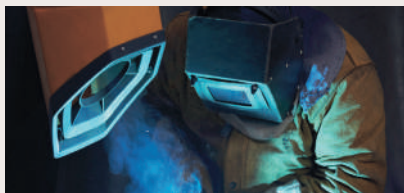

2006

Concluido el desarrollo de las tecnologías **RADIALTEC** y **TERMOPRESS**, e inicio de la fabricación de **ABUJARDADORES**.

*Completed the development of **RADIALTEC** and **TERMOPRESS** technologies and start of the manufacture of **BUSHHAMMERS**.*

— TECHNOLOGIES ▼

**CLOSE**  
**TECH**<sup>®</sup>

**RADIALTEC**<sup>®</sup>

**THERMOPRESS**<sup>®</sup>

**ACTIVE**  
**SHOCK**<sup>®</sup>  
SYSTEM

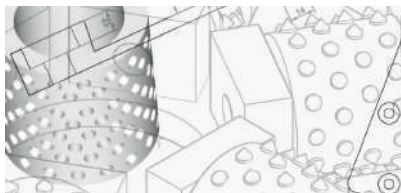

2008

Inicio de la fabricación de productos **QUÍMICOS** para la Limpieza, la Protección y el Mantenimiento.

*Beginning of the manufacture of **CHEMICALS** products for Cleaning, Protection and Maintenance.*

**eco**  
WATER BASE



**ecoembes**





1998

Completado el desarrollo y puesta en producción de **APOMAZADORES**.

*Completed the development and production of **PUMICE-HONING**.*

— TECHNOLOGIES ▼

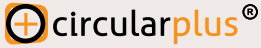

2000

Incorporación a la línea de producción de la familia **CEPILLOS ENVEJECEDORES**.

Finalizadas las obras de la **nueva fábrica** en Alicante.

*Incorporation into the production line of the **AGEING BRUSHES** family. Completed the sites of the **NEW FACTORY** in Alicante.*

— TECHNOLOGIES ▼



2003

Inicio de la fabricación de **ABRASIVOS DIAMANTADOS RESINOIDES (ADR)**.

Explosión en el **mercado internacional**.

*Beginning of the manufacturing of **DIAMOND RESIN ABRASIVES (ADR)**. Explosion in the **international market**.*

— TECHNOLOGIES ▼



2009

Puesta en marcha de la fabricación de **RESINAS EPOXY** y de **POLIESTER**.

*Implementation of the production of **EPOXY AND POLYESTER RESINS**.*



2011

Comienzo de la fabricación de **PEGAMENTOS** y **MASILLAS**.

*Start of the production: **GLUES & MASTICS**.*



2012

Ampliación de las instalaciones de producción. Establecidos los nuevos controles de calidad normalizados: **ISO 9001:2008** y contratación de **CONSEJERO DE SEGURIDAD**. Implantación de sistema de vigilancia externa sobre mercancías peligrosas (ADR).

*Expansion of production facilities. Established the new standard quality control **ISO 9001:2008** and hiring of **SECURITY ADVISER**. Implantation of external security system on dangerous goods (ADR)*



# 2013

Creación de la nueva gama de **PRODUCTOS PARA EL PULIDO DE CERÁMICA.**

*Establishment of the new range of products for the **POLISHING OF CERAMIC.***

— TECHNOLOGIES ▼

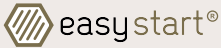

# 2014

Apertura del **CENTRO DE PRODUCCIÓN 2 y NUEVAS OFICINAS.**

*Opening of **PRODUCTION CENTER 2 & NEW OFFICES.***

— TECHNOLOGIES ▼



# 2015

Creación de la nueva gama de productos para el **PULIDO DE CUARZO y PORCELÁNICO.**

*Established the new range of products for the **POLISHING OF QUARTZ AND PORCELAIN.***

— TECHNOLOGIES ▼



# 2018

25 Aniversario de **ABRASIVOS ALICANTE.** Finalizado el desarrollo y comienza la fabricación de la nueva familia de productos **OVAL.** Adecuación al nuevo Reglamento General de Protección de Datos **GDPR.**

*25 Anniversary of **ABRASIVOS ALICANTE.** Completed the development and beginning of the production of new family of **OVAL** products. Adaptation to the new Data Protection Law **GDPR.***



— TECHNOLOGIES ▼



# 2019

Finalizada la implantación del nuevo sistema de gestión de calidad y mejora continua. Abrasivos Alicante forma ya parte de la nueva generación de **Industrias 4.0.** gracias al control digital y monitorización de los procesos productivos.

*Completion of the implementation of the new quality management and continuous improvement system. Abrasivos Alicante is now part of the new generation of **Industrias 4.0.** thanks to the digital control and monitoring of production processes.*

— TECHNOLOGIES ▼



# 2020

Inauguración del 3er Centro de Producción con capacidad para incrementar un 40% la producción total. Inversión clave dentro del programa de expansión de la empresa con las instalaciones más modernas del sector. Desarrollo de productos para uso ambiental frente al Covid-19.

*Inauguration of the 3rd Production Center with the capacity to increase total production by 40%. Key investment in the company's expansion program with the most modern facilities in the sector. Development of products for environmental use against Covid-19.*

— TECHNOLOGIES ▼



2016

Creación de la nueva familia de productos **iFLEX** y **TIGER**.

*Established the two new product families **iFLEX** y **TIGER**.*

— TECHNOLOGIES ▼



2017

Desarrollo de nuevo sistema de pulido **ULTRABOND ECO-SYSTEM** y nueva línea de productos universales: **PUZZLE**. Adaptación e implantación de los nuevos controles de calidad **ISO 9001:2015**.

*Development of new polishing system **ULTRABOND ECO-SYSTEM** and new line of universal products: **PUZZLE**. Adaptation and implementation of the new quality controls **ISO 9001: 2015**.*

— TECHNOLOGIES ▼



HIS  
TO  
RIA

2021

Puesta en marcha de las primeras jornadas técnicas a través de nuestra plataforma presencial **ACADEMY**, donde divulgamos todo nuestro conocimiento técnico con casos prácticos de éxito. Renovamos certificación **ISO 9001** ampliando su cobertura al tercer centro productivo.

*Launch of the first technical conferences through our face-to-face platform **ACADEMY**, where we disseminate all our technical knowledge with practical success stories. We renew **ISO 9001** certification, expanding its coverage to the third production center.*

— TECHNOLOGIES ▼



ISO 9001:2015 CERTIFIED  
www.abrasivosalicante.com

ABRASIVOS  
**ALICANTE**

# QUALITY CALIDAD



En **Abrasivos Alicante** hemos diseñado e implantado nuestro propio sistema de mejora continua y gestión de calidad que actualmente ejecutamos.

Los sistemas de control digital y monitorización de los procesos productivos nos ayudan a gestionar la calidad en tiempo real, aplicando acciones correctivas y preventivas. Con todo ello podemos afirmar que Abrasivos Alicante forma parte de la nueva generación de **industrias 4.0**.

Nuestros sistemas productivos están basados en el sistema de **GESTIÓN LEAN (SGL)** logrando una gran flexibilidad, alta calidad y tiempos de respuesta muy ajustados a las necesidades de nuestros clientes.

Todos estos procesos productivos y de gestión de la calidad están avalados y certificados desde el año 2012 con la norma **ISO: 9001:2015**, auditados por empresas externas homologadas.

*Abrasivos Alicante has designed and implemented our own System of continuous improvement and quality management that we are currently executing.*

*The systems of digital control and monitoring of production processes help us to manage quality in real time, applying corrective and preventive actions. With all this we can affirm that Abrasivos Alicante is part of the new generation of **Industries 4.0***

*Our production systems are based on the **LEAN MANAGEMENT SYSTEM (SGL)** achieving great flexibility, high quality and response times very adjusted to the needs of our customers.*

*All these production and quality management processes have been certified and guaranteed since 2012 with the **ISO: 9001: 2015** standard, audited by approved external companies.*

En **Abrasivos Alicante**, la experiencia nos ha enseñado que los valores son el corazón de toda empresa y la base sobre la que trabajamos día a día con nuestros clientes y "partners".

In **Abrasivos Alicante**, the experience has taught us that the values are the core of any company, and the basis on which we work every day with our customers and partners.

# FILOSOFIA



## INTEGRITY

Trabajando siempre desde el lado más humano, creamos un ambiente de proximidad y conexión con nuestros clientes y proveedores, sin comprometer la verdad. Trabajamos con honestidad para satisfacer sus necesidades y expectativas. Escuchamos y ofrecemos soluciones. Cuidamos su trato generando una relación próspera y duradera en el tiempo, basada en la confianza.

*Always working from the human side, we create an environment of closeness and connection with our customers and suppliers, without compromising the truth. We work with honesty to meet their needs and expectations. We listen and offer solutions. We care about your treatment creating a prosperous and lasting relationship over time, based on trust.*

## TEAM WORK

Nos esforzamos en la creación de un clima de compañerismo y amistad, donde el respeto, la igualdad de oportunidades y el desarrollo individual de cada empleado es una realidad. Trabajamos juntos para conseguir objetivos en común, fomentando el intercambio de ideas e información.

*We strive to create an atmosphere of camaraderie and friendship, where respect, equal opportunities and individual development of each employee, is a reality. We work together to achieve common goals, encouraging the exchange of ideas and information.*

## EXCELLENCE

La calidad, es nuestra meta. La perfección, nuestro camino. Cuidamos cada detalle para poder superar siempre las expectativas de nuestros clientes y ofrecer productos con alto rendimiento y excelente calidad.

*Quality is our goal. Perfection, our way. We care every detail to always exceed the expectations of our customers and offer products with high performance and excellent quality.*

## EFFICIENCY

Optimizamos todos nuestros recursos humanos y técnicos para proporcionar respuestas rápidas y resultados eficaces y precisos en cada uno de nuestros productos y servicios. Aceptamos el cambio como factor necesario para impulsar el crecimiento y abordamos cada reto con creatividad, valentía, colaboración y actitud positiva.

*We optimize all our human and technical resources to provide fast answers, and effective and accurate results in each of our products and services. We accept the change as a necessary factor to boost growth and tackle each challenge with creativity, courage, cooperation and positive attitude.*





# INNOVATION NOVA CION

SOLUCIONES  
INNOVADORAS CON  
TECNOLOGÍA PROPIA  
APLICADA

INNOVATIVE SOLUTIONS  
WITH PROPRIETARY  
TECHNOLOGY APPLIED

**COMPRENDEMOS EL MERCADO, DESARROLLAMOS TECNOLOGIAS.  
WE UNDERSTAND THE MARKET, WE DEVELOP TECHNOLOGIES.**

La continua investigación y unos tiempos record en el desarrollo de nuevos productos, dan como fruto unas soluciones innovadoras con tecnología propia aplicada.

De esta manera Abrasivos Alicante, introduce año tras año, productos e innovaciones al mercado, con un alto valor añadido, respondiendo a las necesidades del mercado.

*Continuous research and a time record in the development of new products, gives as fruit, innovative solutions with our own technology applied.*

*In this way Abrasivos Alicante, introduces year after year innovative products to the market, with high added value responding to market needs.*

# RESEARCH & DEVELOPMENTS



Revolucionario sistema de pulido en solo tres pasos. Reduce pasos innecesarios para conseguir el nivel de pulido y brillo deseados, ahorrando costes de herramienta y tiempo de trabajo.

*Revolutionary polishing system in just three steps. Reduce unnecessary steps to get the level of polish and shine desired, saving costs of tool and work time.*

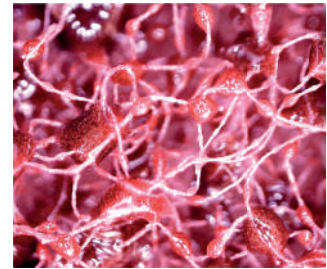

Sistema de pulido diamantado ecológico, con la máxima sencillez de aplicación y una reducción de costes muy considerable respecto al pulido tradicional.

*Ecological diamond polishing system, with maximum application simplicity and a very considerable cost reduction compared to traditional polishing.*



Revolucionario Kit Axial compuesto por un eje y cuatro amortiguadores con geometría variable tipo muelle. Gracias a este sistema es posible absorber eficazmente los golpes que reciben los rodillos durante su trabajo.

*Revolutionary Axle Kit consisting of one axle and four shock absorbers with variable spring type geometry. Thanks to this system it is possible to efficiently absorb the knocks that the rollers receive during their work.*

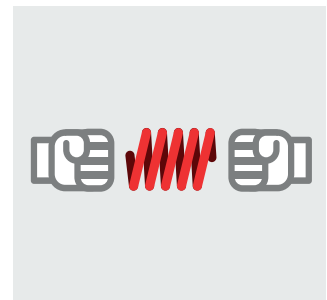

## DIAMOND METALLIC ABRASIVES

Una dispersión controlada y homogénea del diamante, hacen de esta tecnología la combinación perfecta para conseguir abrasivos diamantados superiores.

*A controlled and homogeneous dispersion of the diamonds, makes this technology the perfect combination to achieve superior diamond abrasives.*



## DIAMOND RESINOID ABRASIVES

Una dispersión controlada y homogénea del diamante, hacen de esta tecnología la combinación perfecta para conseguir abrasivos diamantados superiores.

*A controlled and homogeneous dispersion of the diamonds, makes this technology the perfect combination to achieve superior diamond abrasives.*

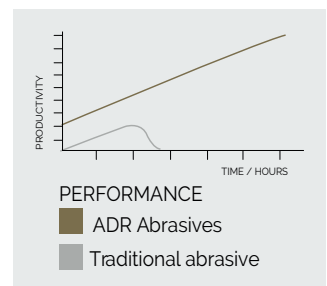

Sistema de equilibrado para herramientas portátiles. Elimina vibraciones y protege la maquinaria ante posibles averías. Además incrementa sustancialmente la vida útil y precisión de las herramientas.

*Balancing system for portable tools. Eliminates vibrations and protects machinery against possible breakdowns. It also substantially increases the useful life and precision of the tools.*



## Basic®

Estructura blindada que no precisa mantenimiento y asegura un funcionamiento perfecto bajo cualquier condición y durante toda la vida útil de los rodillos.

*Armored structure that requires no maintenance and ensures perfect operation under any condition and throughout the life of the rollers.*



## CERAMIC system®

Una dispersión controlada y homogénea del diamante, hacen de esta tecnología la combinación perfecta para conseguir abrasivos diamantados específicos para cerámica.

*A controlled and homogeneous dispersion of the diamonds, makes this technology the perfect combination to achieve specific diamond abrasives for ceramic.*



## ⊕ circularplus®



Mediante la forma circular PATENTADA conseguimos construir herramientas con la máxima densidad, sobre soportes tradicionales no circulares. El resultado son útiles de elevado rendimiento y máxima eficacia.

*Through the PATENTED circular shape we can build tools with maximum density, on traditional non-circular supports. The result is useful for high performance and maximum efficiency.*



## ✘ CLOSE TECH®

Dispersión electrostática mecánica cerrada, que mejora el posicionamiento de los granos de Widia, cumpliendo la normativa FEPA y consiguiendo herramientas con un desgaste muy bajo, con la máxima precisión.

*Closed mechanical electrostatic dispersion, which improves the positioning of Widia grains, complying with FEPA regulations and achieving tools with very low wearing, with the highest precision.*



## DRILL TUFT 3D®

Tecnología que combina el diseño CAD 3D con la construcción del soporte y el insertado de los filamentos en una misma orden de producción, consiguiendo fabricar cepillos técnicos con la máxima precisión y eficacia

*Technology that combines the 3D CAD design with the construction of the support and the insertion of the filaments in the same order of production, achieving the manufacture of technical brushes with maximum precision and efficiency.*

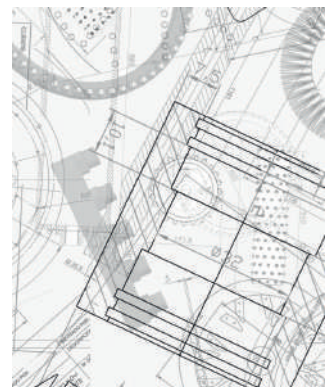





Abrasivos estructurados 100% eficaces desde el comienzo. La micro-estructura lineal definida en la parte superior del producto, posibilita un trabajo perfecto desde el principio, sin necesidad de preparar o abrir la herramienta previamente.

*Structured abrasives, 100% effective from the beginning. The linear micro-structure defined in the upper part of the product, allows a perfect work from the beginning, without the need to prepare or open the tool previously.*

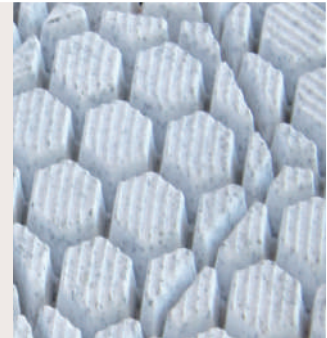

La combinación de fibras sintéticas con resinas de alta flexibilidad posibilitan la creación de abrasivos diamantados innovadores. Tenacidad y ligereza son las principales características de esta nueva tecnología.

*The combination of synthetic fibers with high flexibility resins enables the creation of innovative diamond abrasives. Tenacity and lightness are the main characteristics of this new technology.*



Tecnología flexible para un cuidado exquisito de las superficies a pulir. La construcción de la herramienta combinando piezas flexibles con rígidas garantiza un acople perfecto y un contacto constante sobre las superficies, evitando marcas y rayas en el pulido.

*Flexible technology for an exquisite care of the surfaces to be polished. The construction of the tool combining flexible with rigid parts, guarantees a perfect coupling and a constant contact on the surfaces, avoiding marks and scratches in the polishing.*

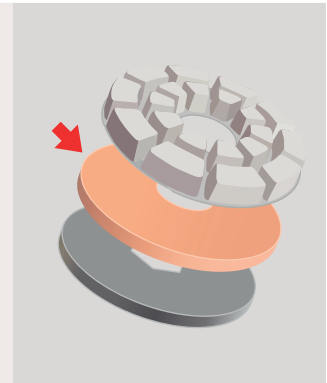

Las durezas GL están pensadas para abrillantar los mármoles más exigentes, donde buscamos un brillo espejo con la máxima profundidad sin sacrificar el rendimiento. Esta tecnología GL combina materias primas naturales de origen animal con un proceso de fabricación sumamente cuidadoso y artesanal, asegurando la máxima calidad de producto.

*The GL hardnesses are produced to shine the most demanding marbles, where we search a mirror shine with maximum depth, without sacrificing performance. This GL technology combines natural raw materials of animal origin with an extremely careful and artisan manufacturing process, ensuring maximum product quality.*



Con esta tecnología aplicada junto con una cuidadosa selección de materias primas y un elaborado proceso productivo, conseguimos crear un cristal extra-duro sobre la superficie pulida del Mármol o Terrazo. Aumenta la dureza de la superficie en la Escala Mohs y la resistencia al rayado.

*With this technology applied together with a careful selection of raw materials and an elaborate production process, we manage to create an extra-hard glass on the polished surface of Marble or Terrazzo. Increases the hardness of the surface in the Mohs Scale and the scratch resistance.*



La estructura geométrica del panal de abeja es la base ideal para construir productos con una estructura muy resistente a la vez que ligera, proporcionando una perfecta refrigeración durante su uso.



*The geometric structure of the honeycomb is the ideal base to build products with a very resistant structure while being light, providing a perfect cooling during use.*

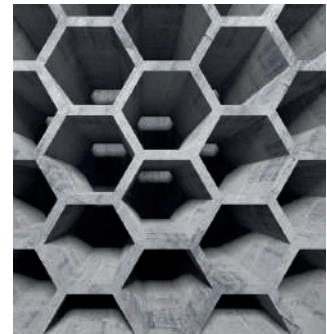

Los diseños entrecruzados exclusivos de esta tecnología, permiten la fabricación de herramientas de última generación para uso tanto en superficies rectas como curvas.

*The exclusive cross-link designs of this technology allows the manufacture of the latest tools for use on both straight and curves surfaces.*



La forma hidrodinámica PATENTADA que reduce el consumo de agua y consigue un mayor rendimiento.

*The PATENTED hydrodynamic form, that reduces water consumption and achieves a higher performance.*

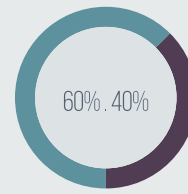

Uso agua / water use

● Standard tool ● Hydrodynamic tool



Rendimiento Performance



Basado en la serie numérica de Fibonacci, se han desarrollado unos productos semiflexibles, consiguiendo texturizar las superficies eficazmente.

*Based on the Fibonacci numerical series, semi-flexible products have been developed, effectively texturing the surfaces.*

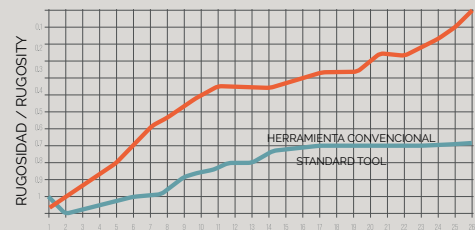

Sistema de fijación magnético, que garantiza un acople perfecto y rápido de la herramienta a la máquina. Posibilidad de instalar este sistema de fijación en maquinaria CNC así como en maquinaria tradicional.

*Magnetic fixing system, which guarantees a perfect and fast coupling of the tool to the machine. this fixing system in CNC machinery as well as in traditional machinery.*

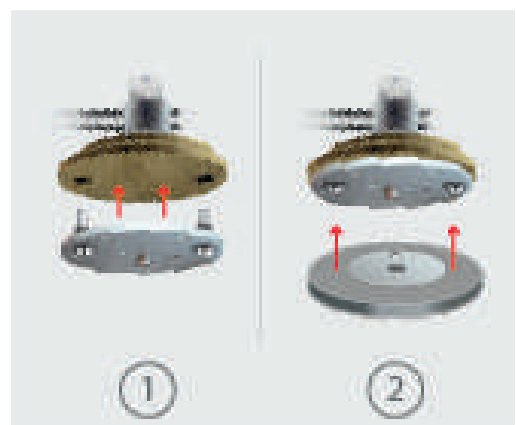



Gracias al diseño Oval aplicado en segmentos ADR, conseguimos herramientas con un diámetro standard adaptable a todas las máquinas existentes. Incrementamos exponencialmente la capacidad de trabajo, reduciendo los tiempos y por consiguiente el coste de pulido.

*Thanks to the Oval design applied in ADR segments, we get tools with a standard diameter adaptable to all existing machines. We increase exponentially the working capacity, reducing the time and therefore the polishing cost.*

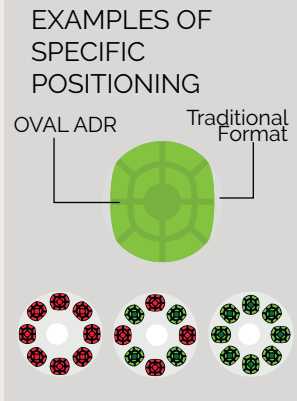

Estructura interna con "doble blindaje", preparada para soportar las máximas cargas asegurando un funcionamiento perfecto bajo cualquier condición y durante toda la vida útil de los rodillos. No precisa mantenimiento, debido a su construcción interna muy robusta autolubricada y su geometría estructural.

*Internal structure with "double shielding", prepared to withstand the maximum loads ensuring a perfect operation under any condition and throughout the life of the rollers. It does not require maintenance, due to its very robust internal self-lubricated construction and its structural geometry.*



Nueva generación de pegamentos en base Epoxy-Acrilato donde conseguimos las mejores propiedades físicas y químicas de los pegamentos Epoxy junto con las ventajas de aplicación de los basados en Poliéster.

*New generation of Epoxy-Acrylate based glues where we achieve the best physical and chemical properties of Epoxy glues together with the application advantages of Polyester based glues.*



Novedoso sistema de enfriamiento muy eficaz, basado en la refrigeración líquida "watercooling". Mantiene la herramienta refrigerada y en condiciones óptimas de trabajo durante toda su vida útil.

*Very effective Innovative cooling system, based on liquid cooling "watercooling". It keeps the tool refrigerated and in optimal working conditions throughout its useful life.*

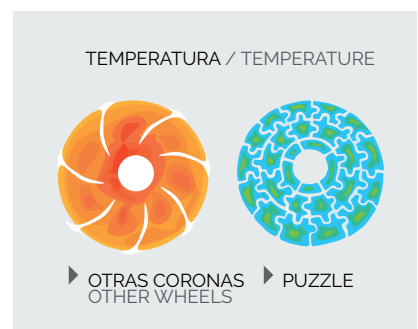

La tecnología radial PATENTADA por Abrasivos Alicante, aporta un aumento de productividad sin precedentes, así como una mejora en la ergonomía del trabajador, reduciendo el peso de la herramienta y evitando molestas vibraciones.

*The radial technology PATENTED by Abrasivos Alicante, provides an unprecedented increase in productivity, as well as an improvement in the ergonomics of the worker, reducing the weight of the tool and avoiding annoying vibrations.*

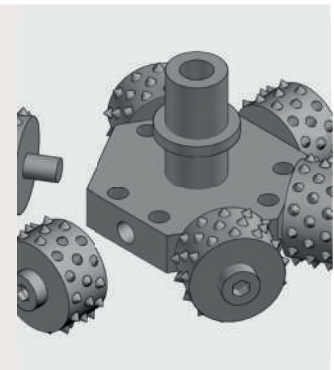



Proceso de restauración y reacondicionamiento de herramientas gastadas, con el que se optimizan al máximo los recursos y se consigue un ahorro extraordinario.

*Restoration and reconditioning process of worn tools, which optimizes resources to the maximum and achieves extraordinary savings.*



Las superficies más delicadas que precisan del mejor acabado, requieren productos abrasivos muy suaves. Las formulaciones RESIN combinan una elaborada selección de minerales, aglutinados con resinas sintéticas específicas, que junto con un proceso productivo controlado, garantizan el mejor acabado con el máximo rendimiento.

*The most delicate surfaces that require the best finish, require very soft abrasive products. RESIN formulations combine an elaborate selection of minerals, bonded with specific synthetic resins, which together with a controlled production process, guarantee the best finish with maximum performance.*



Ejemplo de máxima automatización industrial mediante sistema multi-prensado ejecutado por brazos robóticos totalmente automatizados. Con ello aseguramos la máxima precisión en los procesos y productos con la calidad que nos diferencia.

*Example of maximum industrial automation through multi-press system executed by fully automated robotic arms. With this we ensure maximum precision in the processes and the products with the quality that differentiates us.*



Unas pequeñas incisiones en los soportes, aseguran un acople perfecto de la herramienta en su enganche.

*A few small incisions in the supports, ensure a perfect coupling of the tool in its coupling.*

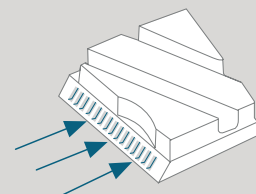

Sistema Multi-Canal diseñado exclusivamente para conseguir una excelente refrigeración. Mantiene la herramienta refrigerada y en condiciones óptimas de trabajo durante toda su vida útil.

*Multi-Channel system designed exclusively to achieve an excellent cooling. It keeps the tool refrigerated and in optimal working conditions throughout its useful life.*

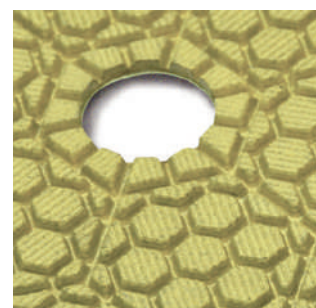



La combinación de minerales con óxido de magnesio, ligados mediante resinas sintéticas en un consolidado proceso productivo, dan como resultado unos productos abrasivos muy económicos y de alto rendimiento a su vez que estables en el tiempo.

*The combination of minerals with magnesium oxide, bound by synthetic resins in a consolidated production process, result in very economical and high performance abrasive products that are also stable over time.*



Innovador sistema de vulcanizado mediante presión en caliente utilizado en la fabricación de herramientas técnicas. Supera al sistema tradicional de construcción, evitando las soldaduras defectuosas y fallos en fabricación.

*Innovative system of vulcanized by hot pressing used in the manufacture of technical tools. It overcomes the traditional construction system, avoiding defective welds and manufacturing failures.*

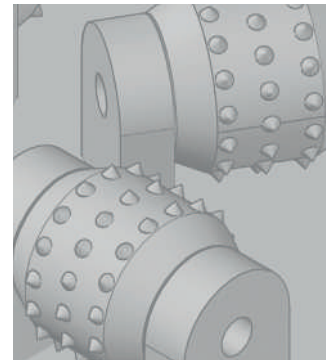

Tecnología diamantada de última generación desarrollada para conseguir productos con un coste muy reducido pero con el máximo rendimiento y calidad.

*Latest generation diamond technology developed to obtain products at a very low cost but with maximum performance and quality.*

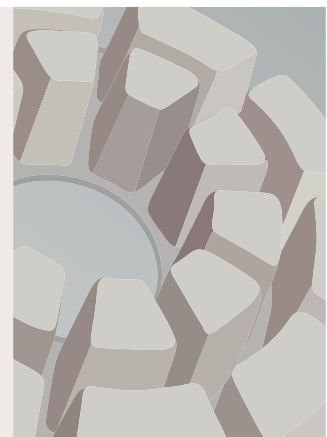

Permite la dispersión exacta y el posicionamiento de los granos de diamante en el exterior de un soporte de tipo red con estructura abierta.

*It allows the exact dispersion and positioning of the diamond grits on the outside of a network type support with an open structure.*

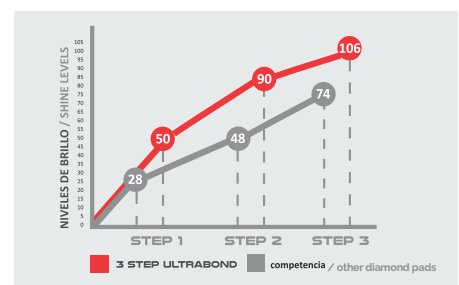

Revolucionaria fórmula diamantada con ausencia de cargas pigmentadas. Elimina el peligro de transferir color a las superficies, consiguiendo un pulido perfecto sobre cualquier superficie.

*Revolutionary diamond formula with absence of pigmented fillers. Eliminates the danger of transferring color to surfaces, achieving a perfect polish on any surface.*



# ÚTILES

TOOLS



DEVELOP  
MENT



ENGINE  
ERING

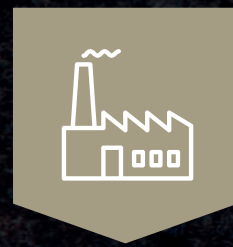

MANU  
FACTURE

DISEÑO, INGENIERÍA Y FABRICACIÓN DE HERRAMIENTAS EFICACES PARA EL TRATAMIENTO DE LA PIEDRA NATURAL, TERRAZO, CERÁMICA, CUARZO & HORMIGÓN.

DESIGN, ENGINEERING AND MANUFACTURING OF EFFECTIVE TOOLS FOR NATURAL STONE, TERRAZZO, CERAMIC, QUARTZ & CONCRETE.



# FABRICACIÓN PROPIA Y PERSONALIZADA

## PROPER & PERSONALIZED PRODUCTION

Nuestro modelo de fabricación nos permite ofrecer diseños propios y a medida, con el fin de poder ofrecer soluciones personalizadas. Nuestro equipo de ingeniería estudia las propuestas que nuestros distribuidores, agentes y clientes nos transmiten, con el fin de ofrecer una solución rápida y eficaz que alcance sus expectativas con éxito y garantías.

Por ello, queremos agradecer a nuestros "partners" su gran labor, confiando en nuestra compañía y permitiéndonos introducir continuamente desarrollos nuevos al mercado.

*Our manufacturing model allows us to offer our own and custom designs in order to offer personalized solutions. Our engineering team studies the proposals that our distributors, agents and customers give us, in order to provide a quick and effective solution that can reach their expectations with success and guarantees.*

*Therefore, we want to thank our partners their great work, trusting our company and allowing us to continually introduce new developments to the market.*



PDF

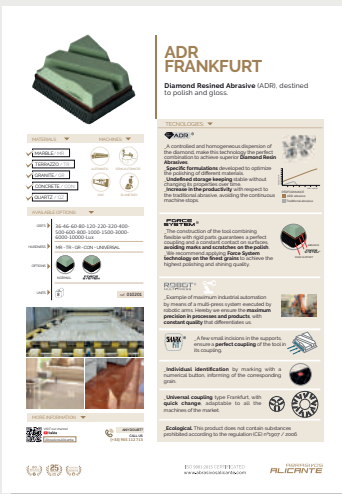

[www.abrasivosalicante.com](http://www.abrasivosalicante.com)

## NUEVAS FICHAS TÉCNICAS NEW TECHNICAL DATA SHEETS

- ▶ Utiliza las nuevas fichas de producto con toda la información técnica actualizada.
- ▶ Use the new product data sheets with all the current technical information.



Encuentra en Youtube nuestros videos explicativos con ejemplos de aplicación.

*Find on Youtube our explanatory videos with application examples.*



[youtube.com/abrasivosalicante](https://youtube.com/abrasivosalicante)

# FICKERT

Denominamos FICKERT a una gran familia de productos de fijación rápida. Su forma es rectangular y está provista de un soporte rígido por donde se fija a la maquinaria. Su movimiento, además de describir una circunferencia, oscila como si de un péndulo se tratara, incidiendo eficazmente sobre las superficies más exigentes.

En la actualidad fabricamos una gran variedad de productos, consiguiendo acabados que van desde un calibrado o pulido, hasta un abrillantado espejo, pasando por novedosas texturas muy solicitadas en esta última década como son los envejecidos, abujardados, apomazados, arenados y texturizados muy suaves.

---

*We name **FICKERT** a large family of quick fix products. Its shape is rectangular and is provided with a rigid support where it is fixed to the machinery. Its movement, in addition to describing a circumference, oscillates as if it were a pendulum, effectively affecting the most demanding surfaces.*

*We currently manufacture a wide variety of products, getting finishes ranging from a calibrated or polished finish, to a polished mirror shine, through novel textures much demanded in this last decade such as aged, bush hammered, honed, sandblasted and very smooth textures.*







## FICKERT ADM / FICKERT ADM

Abrasivo Diamantado Metálico (ADM) destinado al calibrado y desbaste.

*Diamond Metallic Abrasive (ADM), destined to calibrate and grind.*

MATERIALES / MATERIALS ▼

✓ GRANITE / GR

✓ CERAMIC / CR

✓ QUARTZ / QZ

✓ CONCRETE / CON

MÁQUINAS / MACHINES ▼



OPCIONES DISPONIBLES / AVAILABLE OPTIONS ▼

GRANOS / GRITS ▶ 30-40-50-60-80-100-120-140-170-200-230

DUREZA / HARDNESS ▶ GR / QZ / CR

OPCIONES / OPTIONS ▶  140mm

 170mm

UNIDADES / UNITS ▶ 

ref. 020101



TECHNOLOGIES ▼



ROBOT  
MULTI-PRESS

## FICKERT ADR 140MM / 140MM FICKERT ADR

Abrasivo Diamantado Resinoide (ADR), destinado al pulido y abrillantado.

*Diamond Resined Abrasive (ADR), destined to polish and gloss.*

MATERIALES / MATERIALS ▼

✓ GRANITE / GR

✓ CERAMIC / CR

✓ QUARTZ / QZ

✓ CONCRETE / CON

MÁQUINAS / MACHINES ▼



OPCIONES DISPONIBLES / AVAILABLE OPTIONS ▼

GRANOS / GRITS ▶ 36-46-60-80-100-120-150-180-220-240-280-320-400-600-800-1000-1200-1500-1800-2000-3000-4000-5000-6000-Lux

DUREZA / HARDNESS ▶ GR / QZ / CR / CON

UNIDADES / UNITS ▶ 

ref. 020201



TECHNOLOGIES ▼



ROBOT  
MULTI-PRESS



## FICKERT ADR 160MM / 160MM FICKERT ADR

Abrasivo Diamantado Resinoide (ADR), destinado al pulido y abrillantado.

*Diamond Resined Abrasive (ADR), destined to polish and gloss.*

MATERIALES / MATERIALS ▼

✓ QUARTZ / QZ

✓ CERAMIC / CR

MÁQUINAS / MACHINES ▼



OPCIONES DISPONIBLES / AVAILABLE OPTIONS ▼

GRANOS / GRITS ▼ 36-46-60-80-100-120-150-180-220-240-280-320-400-600-800-1000-1200-1500-1800-2000-3000-4000-5000-6000-Lux

DUREZA / HARDNESS ▼ QZ / CR / GR

OPCIONES / OPTIONS ▼



UNIDADES / UNITS ▼



ref. 020202



TECHNOLOGIES ▼



## FICKERT ADR 170MM / 170MM FICKERT ADR

Abrasivo Diamantado Resinoide (ADR), destinado al pulido y abrillantado.

*Diamond Resined Abrasive (ADR), destined to polish and gloss.*

MATERIALES / MATERIALS ▼

✓ QUARTZ / QZ

✓ CERAMIC / CR

MÁQUINAS / MACHINES ▼



OPCIONES DISPONIBLES / AVAILABLE OPTIONS ▼

GRANOS / GRITS ▼ 36-46-60-80-100-120-150-180-220-240-280-320-400-600-800-1000-1200-1500-1800-2000-3000-4000-5000-6000-Lux

DUREZA / HARDNESS ▼ QZ / CR / GR

OPCIONES / OPTIONS ▼



UNIDADES / UNITS ▼



ref. 020203



TECHNOLOGIES ▼



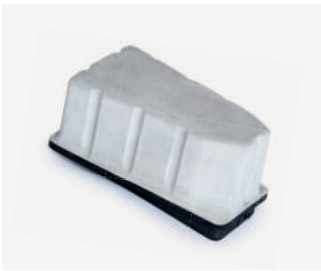

## FICKERT 140MM / 140MM FICKERT

Producto abrasivo con enganche Fickert destinado al Calibrado, Pulido y Abrillantado.

*Abrasive product with Fickert coupling destined to Calibrate, Polish and Shine.*

MATERIALES / MATERIALS ▼

- ✓ GRANITE / GR
- ✓ CERAMIC / CR
- ✓ QUARTZ / QZ
- ✓ CONCRETE / CON

MÁQUINAS / MACHINES ▼



OPCIONES DISPONIBLES / AVAILABLE OPTIONS ▼

GRANOS  
GRITS

16-24-36-46-60-80-120-150-180-  
220-240-280-320-360-400-500-  
600-800-1000-1200-1500 - Lux



Lux



SuperLUX

DUREZA  
HARDNESS

GR / CR / QZ

MEDIDAS  
MEASURES



140mm

ref. 020301



140mm Plus

ref. 020302



UNIDADES  
UNITS

140mm

24

140mm Plus

20



TECHNOLOGIES

SYNTEX<sup>®</sup>

RESIN<sup>®</sup>

## FICKERT 170MM / 170MM FICKERT

Producto abrasivo con enganche Fickert destinado al Calibrado, Pulido y Abrillantado.

*Abrasive product with Fickert coupling destined to Calibrate, Polish and Shine.*

MATERIALES / MATERIALS ▼

- ✓ GRANITE / GR
- ✓ CERAMIC / CR
- ✓ QUARTZ / QZ

MÁQUINAS / MACHINES ▼



OPCIONES DISPONIBLES / AVAILABLE OPTIONS ▼

GRANOS  
GRITS

SYNTEX<sup>®</sup>  
FORMULA

16-18-24-36-46-60-80-120-150-  
180-220-240-280-320-360-400-  
500-600-800-1000-1200-1500  
Lux

DUREZA  
HARDNESS

GR / CR / QZ

UNIDADES  
UNITS

18

ref. 020303



TECHNOLOGIES

SYNTEX<sup>®</sup>



## FICKERT LAP ADR / FICKERT ADR LAP

Abrasivo Diamantado Resinoide (ADR), destinado al "Lapeado" y semipulido.

*Diamond Resined Abrasive (ADR), destined to "Lapping" and Semi-Polishing.*

MATERIALES / MATERIALS ▼

✓ CERAMIC / CR

MÁQUINAS / MACHINES ▼



OPCIONES DISPONIBLES / AVAILABLE OPTIONS ▼

GRANOS  
GRITS

60-80-100-120-150-180-220-  
240-280-320-400-600-800  
1000-1200-1500-1800-2000-  
3000-4000-5000-6000

MEDIDAS  
MEASURES



UNIDADES  
UNITS



ref. 020204



TECHNOLOGIES ▼



## FICKERT FIELTRO / FICKERT FELT

Producto fabricado con lana virgen de primera calidad destinado a la limpieza y abrillantado.

*Product produced with first quality virgin wool destined to clean and shine.*

MATERIALES / MATERIALS ▼

✓ GRANITE / GR

✓ CERAMIC / CR

✓ QUARTZ / QZ

✓ CONCRETE / CON

MÁQUINAS / MACHINES ▼



OPCIONES DISPONIBLES / AVAILABLE OPTIONS ▼

UNIDADES  
UNITS



ref. 020601



TECHNOLOGIES ▼





## FICKERT APOMAZADOR / FICKERT PUMICE-HONING

Producto destinado al "Apomazado", consiguiendo un acabado mate uniforme.

*Product destined to "Hone", obtaining a uniform matt finish.*

MATERIALES / MATERIALS ▼

- ✓ GRANITE / GR
- ✓ CERAMIC / CR
- ✓ QUARTZ / QZ
- ✓ CONCRETE / CON

MÁQUINAS / MACHINES ▼



OPCIONES DISPONIBLES / AVAILABLE OPTIONS ▼

GRANOS  
GRITS

**Corundum :**

60-100-120-180-320

**Sci:**

60-100-120-180-320-500-600-1000-1200

MEDIDAS  
MEASURES

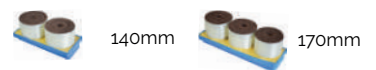

UNIDADES  
UNITS



ref. 020701

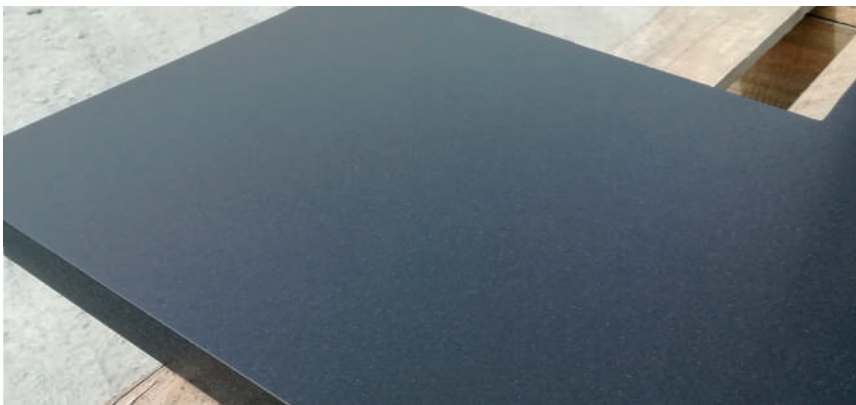

TECHNOLOGIES ▼



## CEPILLO FICKERT PLUS / FICKERT PLUS BRUSH

Cepillo de alto rendimiento destinado al "Envejecido" de pavimentos.

*High-performance brush destined to obtain "Aged Finish" on floors.*

MATERIALES / MATERIALS ▼

- ✓ GRANITE / GR
- ✓ CERAMIC / CR
- ✓ QUARTZ / QZ
- ✓ CONCRETE / CON

MÁQUINAS / MACHINES ▼



OPCIONES DISPONIBLES / AVAILABLE OPTIONS ▼

GRANOS  
GRITS

\*Ver gráfico / See graphic

INOX  
MIXTO (INOX+36)  
INOX GOLD  
24-36-46-60-80-120-180-240-320-500-600-800-1000  
CLEAN

OPCIONES  
OPTIONS



MEDIDAS  
MEASURES



UNIDADES  
UNITS



**INOX**

Los cepillos de acero inoxidable son utilizados para eliminar la tierra de las fisuras antes de tratar la superficie con masillas. Se suministran siempre resinados.

*The stainless steel brushes are used to eliminate the sand of the fissures before treating the surface with mastics. They are always supplied resin coated.*



**MIXTO**

Los cepillos combinan filamentos abrasivos de grano 36 con filamentos de acero inoxidable. Su uso, agliza el proceso de envejecido y acentúa la textura resultante.

*These brushes combine filaments grit 36 with stainless steel filaments. Its use quickens the ageing process and accentuates the resulting texture.*



**INOX GOLD**

Los cepillos de acero trenzado GOLD son utilizados para texturizar rápida y energicamente materiales duros como el granito. Además elimina la tierra en las fisuras de los materiales. Se suministran siempre resinados.

*The GOLD braided steel brushes are used to quickly and energetically texture hard materials such as granite. It also removes dirt from the cracks in materials. They are always supplied resin-coated.*



**CLEAN**

Los cepillos limpiadores no contienen abrasivo y están destinados a la limpieza de materiales o aplicación de productos químicos.

*The cleaning brushes do not contain abrasive and are destined to clean materials or to apply chemical products.*

TECHNOLOGIES ▼

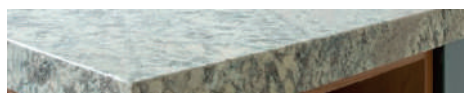



## CEPILLO DIAMANTADO FICKERT PLUS FICKERT PLUS DIAMOND BRUSH

Cepillo diamantado de máximo rendimiento destinado a "Satinar" y "Envejecer".

*High performance diamond brush designed to "Satin" and to "Age".*

MATERIALES / MATERIALS ▼

✓ GRANITE / GR

✓ CERAMIC / CR

✓ QUARTZ / QZ

✓ CONCRETE / CON

MÁQUINAS / MACHINES ▼



### NORMAL



Para el tratamiento de Mármoles y superficies de dureza media, recomendamos los cepillos Normales para conseguir la máxima flexibilidad de los filamentos y por consiguiente un mayor texturizado.

*For the treatment of marbles and surfaces of medium hardness, we recommend the Normal brushes to achieve the maximum flexibility of the filaments and therefore a greater texturization.*



Todos los cepillos se pueden suministrar resinados. Esto permite aplicar mayor presión sobre los útiles en el proceso, consiguiendo una mayor textura. Opción recomendada para el tratamiento de piedras muy duras.

*All brushes can be resin coated. This allows to apply greater pressure on the tools in the process, achieving a greater texture. Recommended option when treating very hard stones.*

OPCIONES DISPONIBLES / AVAILABLE OPTIONS ▼

GRANOS  
GRITS

24-36-46-60-80-120-180-  
240-320-400-500-600-800-  
1000-1200-1400-1600-  
1800-3000-3500-6000

OPCIONES  
OPTIONS



NORMAL



RESIN®

MEDIDAS  
MEASURES



140mm

170mm

UNIDADES  
UNITS

140mm

36

170mm

30

TECHNOLOGIES ▼



## FICKERT PLUS DIAMOND IFLEX FICKERT PLUS DIAMOND IFLEX

Abrasivo diamantado flexible destinado a crear novedosas texturas: Efecto "Leather", "Caricia", "Seda", "Envejecido", "Satinado", "Lapeado", "Apomazado"... así como acabado pulido y de alto brillo.

*Flexible diamond abrasive destined to create new textures: "Leather", "Caress", "Silk", "Antic", "Satin", "Lapped", "Honed" .... as well as polished finish and high gloss.*

MATERIALES / MATERIALS ▼

✓ GRANITE / GR

✓ CERAMIC / CR

✓ QUARTZ / QZ

MÁQUINAS / MACHINES ▼



OPCIONES DISPONIBLES / AVAILABLE OPTIONS ▼

GRANOS  
GRITS

24-36-46-60-120-220-320-400-  
600-800-1000-1200-1500-3500  
SuperLUX

UNIDADES  
UNITS

6

ref. 021001



TECHNOLOGIES ▼





## FICKERT ABUJARDADOR / FICKERT BUSHHAMMER

Novedoso sistema abujardador patentado con fijación Fickert.

*Novel patented bushhammer system with Fickert coupling.*



MATERIALES / MATERIALS ▼

- ✓ GRANITE / GR
- ✓ CONCRETE / CON

- ✓ QUARTZ / QZ
- ✓ MARBLE / MR

MÁQUINAS / MACHINES ▼



OPCIONES DISPONIBLES / AVAILABLE OPTIONS ▼

DUREZA  
HARDNESS

OPCIONES  
OPTIONS



Basic® / PLUS®



UNIDADES  
UNITS



ref. 021101

TECHNOLOGIES ▼



## FICKERT ARENADOR / FICKERT SANDBLAST

Abrasivo Diamantado Resinoide (ADR), destinado al pulido y abrillatado.

*Diamond Resined Abrasive (ADR), destined to polish and gloss.*

MATERIALES / MATERIALS ▼

- ✓ GRANITE / GR
- ✓ CONCRETE / CON

- ✓ QUARTZ / QZ
- ✓ MARBLE / MR

MÁQUINAS / MACHINES ▼



OPCIONES DISPONIBLES / AVAILABLE OPTIONS ▼

DUREZA  
HARDNESS

OPCIONES  
OPTIONS



Basic® / PLUS®



UNIDADES  
UNITS



ref. 021201

TECHNOLOGIES ▼



# 75MM 180MM

Esta gran familia de útiles circulares está formada por herramientas con diámetros comprendidos entre 75mm y 180mm. Fabricamos desde productos para el tratamiento superficial, hasta productos para el pulido de cantos. Además disponemos de un sin fin de enganches para cada producto, adaptándonos a cualquier máquina del mercado.

---

*This large family of circular tools is made up of tools with diameters between 75mm and 180mm. We manufacture from products for the treatment of surfaces to products for the polishing of edges. We also have an endless number of couplings for each product, adapting to any machine on the market.*







## CORONAS ADM TIGER / ADM TIGER WHEELS

Abrasivo Diamantado Metálico (ADM) destinado al calibrado y desbaste.

*Diamond Metallic Abrasive (ADM) destined to calibrate and grind.*

MATERIALES / MATERIALS ▼

✓ CERAMIC / CR

MÁQUINAS / MACHINES ▼



OPCIONES DISPONIBLES / AVAILABLE OPTIONS ▼

GRANOS / GRITS 50-100-200

UNIDADES / UNITS 1

ref. 050104

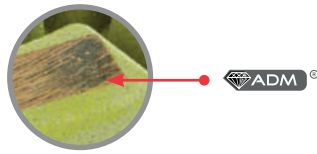

	FIJACIÓN / COUPLING	FORMATO / TYPE
<b>100mm</b> (4")		
<b>125mm</b> (5")		
<b>150mm</b> (6")		

TECHNOLOGIES ▼



ROBOT  
MULTI-PRESS

## CORONAS ADR TIGER / ADR TIGER WHEELS

Abrasivo Diamantado Resinoide (ADR) destinado al pulido y abrillantado.

*Diamond Resined Abrasive (ADR) destined to polish and gloss.*



MATERIALES / MATERIALS ▼

✓ CERAMIC / CR

MÁQUINAS / MACHINES ▼



OPCIONES DISPONIBLES / AVAILABLE OPTIONS ▼

GRANOS / GRITS 50-100-200-400-800-1500-3000  
White Shine - Black Shine

OPCIONES / OPTIONS NORMAL FORCE SYSTEM®

UNIDADES / UNITS 1

ref. 050204



TECHNOLOGIES ▼



FORCE SYSTEM®

ROBOT  
MULTI-PRESS





PRÓXIMAMENTE NUEVO PRODUCTO  
SOON NEW PRODUCT

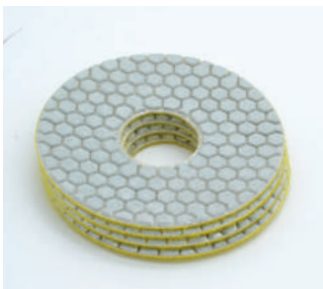

**LIJA ADR HONEY-COMB CERAMIC WET&DRY**  
**ADR HONEY-COMB CERAMIC WET&DRY PAD**



Abrasivo Diamantado Resinoide (ADR) Flexible, destinado al Pulido de biseles. Capaz de conseguir la más alta calidad sin aporte de agua.

*Flexible Diamond Resined Abrasive (ADR) designed to Polish bevels. Able to achieve the best quality without needing water.*

MATERIALES / MATERIALS ▼

✓ CERAMIC / CR

MÁQUINAS / MACHINES ▼



OPCIONES DISPONIBLES / AVAILABLE OPTIONS ▼

- GRANOS / GRITS ▼ 100-200-400
- MEDIDAS / MEASURES ▼ 125 mm (5")
- FIJACIÓN / COUPLING ▼ (VEL)
- UNIDADES / UNITS ▼ 10

ref. 051519



VIDEO  
PRODUCT



TECHNOLOGIES ▼





ISO 9001:2015 CERTIFIED  
[www.abrasivosalicante.com](http://www.abrasivosalicante.com)

**ABRASIVOS**  
**ALICANTE** 35

# 200MM 900MM

Abrasivos Alicante fabrica productos en grandes diámetros, que van desde los 200mm hasta los 900mm, destinados al tratamiento de superficies duras donde aplicamos numerosas tecnologías.

Es posible fabricar a medida muchos de estos productos respondiendo a necesidades concretas y adaptándonos a cualquier máquina del mercado, en un tiempo record.

---

*Abrasives Alicante manufactures products in large diameters, ranging from 200mm to 900mm, intended for the treatment of hard surfaces where we apply numerous proprietary technologies.*

*It's possible to produce many of these products exclusively responding to specific needs and adapting them to any machine on the market, in record time.*



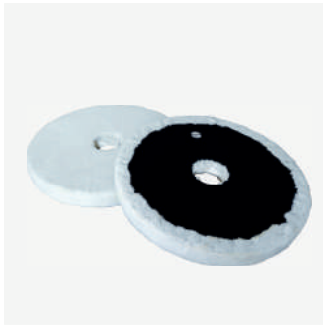

## CORONAS DE BORREGUILLO / WOOLLEN WHEELS

Coronas de piel de cordero, destinadas al abrillantado de superficies.

*Lambskin wheels, destined for shining and cleaning surfaces.*

MATERIALES / MATERIALS ▼

✓ TODO TIPO DE MATERIALES  
ALL TYPE OF MATERIALS.

MÁQUINAS / MACHINES ▼



OPCIONES DISPONIBLES / AVAILABLE OPTIONS ▼

MEDIDAS / MEASURES  
330mm (13")  
431mm (17")  
505mm (20")

**madeto**  
**measure**  
Fabricación de cualquier diámetro.  
Production in any diameter.

FIJACIÓN / COUPLING  
SP VEL MG

UNIDADES / UNITS  
1

ref. 061705

ASSOCIATED PRODUCT ▼

STONE KIT 3D



TECHNOLOGIES ▼

FORCE  
SYSTEM®



## CORONAS LIMPIADORAS / CLEANING WHEELS

Cepillos limpiadores, destinados a la limpieza y abrillantado de superficies.

*Cleaning brushes destineted to clean and shine surfaces.*

MATERIALES / MATERIALS ▼

✓ TODO TIPO DE MATERIALES  
ALL TYPE OF MATERIALS.

MÁQUINAS / MACHINES ▼



OPCIONES DISPONIBLES / AVAILABLE OPTIONS ▼

MEDIDAS / MEASURES  
330mm (13")  
431mm (17")  
505mm (20")

**madeto**  
**measure**  
Fabricación de cualquier diámetro.  
Production in any diameter.

FIJACIÓN / COUPLING  
SP VEL MG

UNIDADES / UNITS  
5

ref. 060801

ASSOCIATED PRODUCT ▼

STONE KIT 3D



TECHNOLOGIES ▼

DRILL  
TUFT3D®

MG SYSTEM®





## PLATO ABUJARDADOR / BUSHHAMMER PLATE

Plato Abujardador / Arenador muy robusto, con tecnología propia aplicada, adaptable a todas las máquinas del mercado.

*Very robust Bushhammer/Sandblast plate, with proper applied technology, adaptable to all the machines of the market.*

MEDIDAS MEASURES	Nº RODILLOS Nº ROLLERS	
200mm (7,8')	3	
270mm (11')	6	
320mm (12')	6 8	
350mm (13,7')	6 8	
400mm (14,7')	8 12	
460mm (18')	8 12 16	
500mm (19,6')	8 12 16	

### MATERIALES / MATERIALS

- MARBLE / MR
- CONCRETE / CON
- GRANITE / GR
- OTHER STONES

### MÁQUINAS / MACHINES



### OPCIONES DISPONIBLES / AVAILABLE OPTIONS

DUREZA  
HARDNESS  
UNIDADES  
UNITS

Basic® / PLUS®



ref. 061101

### FÁCIL INTERCAMBIO / EASY EXCHANGE



VIDEO  
PRODUCT



### TECHNOLOGIES

Basic®

PLUS®

CLOSE  
TECH

THERMOPRESS®

ACTIVE  
SHOCK()  
SYSTEM



ACABADOS ABUJARDADOS / BUSHHAMMER FINISH ▼



SCALE 11

ACABADOS ARENADOS / SANDBLAST FINISH ▼



SCALE 11

Muestras realizadas sobre Mármol Crema Marfil.  
Samples made on Crema Marfil marble.



CHE  
MICALS

# QUÍ MICOS



CLEA  
NING



PRO  
TECTION



MAIN  
TENANCE

Con una gran experiencia consolidada en el sector químico, desde Abrasivos Alicante ofrecemos una total garantía de calidad y rendimiento en todos nuestros productos de LIMPIEZA, PROTECCIÓN Y MANTENIMIENTO de superficies duras como: Mármol, Caliza, Terrazo, Arenisca, Cuarzita, Granito, Cuarzo, Ultracompacto, Pizarra, Hormigón, Cemento, Barro, Gres, Hidráulico...

Having consolidated a great experience in the chemical sector, Abrasivos Alicante guarantees quality and performance in our CLEANING, PROTECTING AND MAINTENANCE products for hard surfaces like: Marble, Limestone, Terrazzo, Sandstone, Quartzite, Granite, Quartz, Ultracompact, Slate, Concrete, Cement, Clay, Porcelain, Hydraulic...







# COMPROMISO CON EL MEDIO AMBIENTE.

## COMMITMENT TO THE ENVIRONMENT

Hace ya bastante tiempo que adquirimos un compromiso con el medio ambiente, modificando conductas y adaptando procesos en toda nuestra línea de producción y métodos de trabajo. Hoy día podemos afirmar que los objetivos marcados por Abrasivos Alicante en aras de colaborar enérgicamente con el medio ambiente han obtenido sus frutos, muestra de lo cual son los reconocimientos de entidades como ECOEMBES y la distinción de EMPRESA VERDE otorgada recientemente por COEPA.

*It has been a while since we committed ourselves to the environment, modifying our behaviours and adapting processes in our productive lines and working methods. Today we can confirm that these environmental targets have been achieved, shown by the acknowledgement of entities such as ECOEMBES and the distinction of GREEN COMPANY recently granted to us by COEPA.*

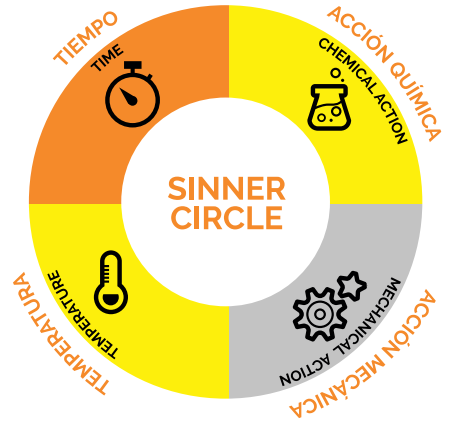

Basados en la **Teoría de Sinner**, comprendemos que los factores ideales para conseguir una buena limpieza y tratamiento, rara vez se dan. Por ello nuestro equipo técnico investiga y desarrolla productos con formulaciones eficaces, que permitan optimizar los recursos, reduciendo los tiempos de aplicación.

*Based on the Theory of Sinner, we understand that the ideal factors which ensure good cleaning and treatment are rarely present. Our technical team investigates and develops products with efficient formulas towards this end, allowing the optimisation of resources and reducing application times.*

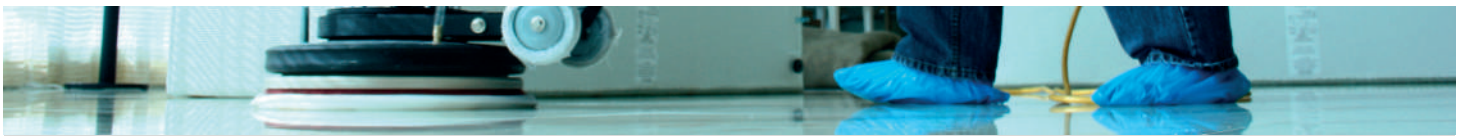

PDF



[www.abrasivosalicante.com](http://www.abrasivosalicante.com)

## NUEVAS FICHAS TÉCNICAS

## NEW TECHNICAL DATA SHEETS

- ▶ Utiliza las nuevas fichas de producto con toda la información técnica actualizada.
- ▶ Use the new product data sheets with all the current technical information.



Encuentra en Youtube nuestros videos explicativos con ejemplos de aplicación.

*Find on Youtube our explanatory videos with application examples.*



[youtube.com/abrasivosalicante](https://youtube.com/abrasivosalicante)



ISO 9001:2015 CERTIFIED  
[www.abrasivosalicante.com](http://www.abrasivosalicante.com)

ABRASIVOS  
**ALICANTE**



**STONE KIT 3D**

Kit de limpieza, abrillantado y protección.  
*Cleaning, polishing and protecting kit.*



MATERIALES / MATERIALS ▼

- ✓ MÁRMOL/MARBLE
- ✓ GRANITO/GRANITE
- ✓ CERAMIC / CR
- ✓ PIEDRAS ORNAMENTALES  
ORNAMENTAL STONES

TECNOLOGÍAS / TECHNOLOGIES ▼

- ✓ Alto brillo / *High shine*
- ✓ Máxima protección / *Maximum protection*
- ✓ Altamente efectivo / *Highly effective*
- ✓ Muy duradero / *Very long-lasting*
- ✓ Fácil aplicación / *Easy application*

APLICACIONES / APPLICATIONS ▼



USO  
USE



RENDIMIENTO  
PERFORMANCE

**1 LITRO PUEDE TRATAR / 1 LITER CAN TREAT**

Aplicación manual / *Manual application*  
(100%) 50-100 m<sup>2</sup>

Aplicación Automática / *Automatic application*  
(100%) 100-150 m<sup>2</sup>

*\*El rendimiento es orientativo, ver modo de empleo.  
\*The performance is indicative, see use method.*

UNIDADES  
UNITS

500 ml + 2 bayetas/cloths



5 Litros / *Liters*



25 Litros / *Liters*



ref. 082104



 **TINT**



Tinte para Piedra, formulado especialmente para modificar o incrementar su tonalidad o color. Una vez seco, la Piedra quedará perfectamente tintada con un resultado asombroso.

*Stone Tint, specially formulated to modify or increase the tone or colour. Once dry, the Stone will be perfectly tinted with an astonishing result.*



MATERIALES / MATERIALS ▼

- ✓  **PIEDRA NATURAL Y ARTIFICIAL**  
NATURAL AND ARTIFICIAL STONE
- ✓  **HORMIGÓN/CONCRETE**
- ✓  **CEMENTO/CEMENT**

APLICACIONES / APPLICATIONS ▼



USO  
USE



RENDIMIENTO  
PERFORMANCE

**1 LITRO PUEDE TRATAR / 1 LITER CAN TREAT**

Aplicación manual / Manual application  
(100%) 10-20 m<sup>2</sup>

Aplicación Automática / Automatic application  
(100%) 10-20 m<sup>2</sup>

Aplicación mediante spray / Application with spray  
(100%) 20-40 m<sup>2</sup>

*\*El rendimiento es orientativo, ver modo de empleo.  
\*The performance is indicative, see use method.*

COLOR  
COLOUR



UNIDADES  
UNITS

1 Litro / Liter



5 Litros / Liters



ref. 081701

VIDEO  
PRODUCT  
 YouTube



MASTICS & RESINS

# MASILLAS & RESINAS



GLUES



MASTICS



RESINS

FABRICACIÓN DE TONALIDADES ESTÁNDAR  
Y ESPECÍFICAS BAJO DEMANDA.

MANUFACTURE OF STANDARD AND ALSO  
SPECIFIC COLOURS ON DEMAND.

Desde Abrasivos Alicante ofrecemos una extensa gama de Masillas, Pegamentos y Resinas desarrolladas en base Poliester y como novedad también en base Epoxi-Acrilato (Poliepoxi), así como Sistemas Epoxi, destinados al filtrado, reforzado y pegado de superficies pétreas.

*Abrasives Alicante offers an extensive range of Mastics, Glues and Resins developed on Polyester base and as a novelty also on Epoxy-Acrylate (Polyepox) base, as well as Epoxy Systems, destined for the filtering, reinforcing and bonding of stone surfaces.*



# GUARANTEE & QUALITY

## RESPUESTA INMEDIATA A LAS NECESIDADES DEL MERCADO. IMMEDIATE RESPONSE TO MARKET NEEDS

Muchas de las materias primas son desarrolladas en exclusiva por nuestros partners; que junto con los productos finales, son controlados rigurosamente por nuestro laboratorio, ofreciendo la mayor garantía y compromiso de mejora continua del sistema de calidad implantado.

Por otro lado, agradecemos a nuestra red de distribuidores su gran labor, al comunicarnos las inquietudes del consumidor, base de todos nuestros desarrollos y programas de trabajo.

*Many of the raw materials are developed exclusively by our partners; which together with the final products are strictly controlled by our laboratory, offering the greatest guarantee and commitment to continuous improvement of the implanted quality system.*

*Furthermore, we thank our distributors for their great support, in communicating the concerns of the consumer, which is the base of all our developments and working programs.*



PDF

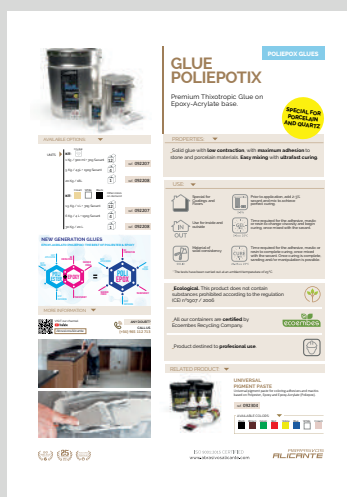

[www.abrasivosalicante.com](http://www.abrasivosalicante.com)

## NUEVAS FICHAS TÉCNICAS

## NEW TECHNICAL DATA SHEETS

- ▶ Utiliza las nuevas fichas de producto con toda la información técnica actualizada.
- ▶ Use the new product data sheets with all the current technical information.



Encuentra en Youtube nuestros videos explicativos con ejemplos de aplicación.

*Find on Youtube our explanatory videos with application examples.*



[youtube.com/abrasivosalicante](https://youtube.com/abrasivosalicante)

## EPOXY RESINS



### CRYSTAL-POX

Resina Epoxy Cristalina para Piedra.

*Crystal Epoxy Resin for Stone.*

Sistemas Epoxy formulados para el refuerzo con fibra de vidrio y el filtrado de Mármoles y Granitos. Nuestros sistemas proporcionan una extraordinaria resistencia mecánica a la temperatura, al fuego, a la humedad y a la corrosión por ácidos y bases. Tienen un elevado poder de adhesión, una mínima contracción al curado y se diferencian por ser sumamente incoloros.

*Epoxy Systems specially formulated for the reinforcement with fiberglass and filtering of Marbles and Granites. Our systems provide an extraordinary mechanical resistance to temperature, fire, moisture and corrosion by acids and bases. They also have great adhesive power, a minimum curing contraction and are differentiated by being extremely colourless.*

OPCIONES DISPONIBLES / AVAILABLE OPTIONS ▼

COLOR  
COLOUR



UNIDADES  
UNITS

25 Kg



1000 Kg



ref. 092404

## ESPECIAL FILTRADO / SPECIAL FILLING

**SPEED**  
SYSTEM



R350 + B350



**SLOW**  
SYSTEM



R450 + B450



## ESPECIAL REFUERZO / SPECIAL REINFORCEMENT

**SPEED**  
SYSTEM



R1000 + B1000



**SLOW**  
SYSTEM



R800 + B2002

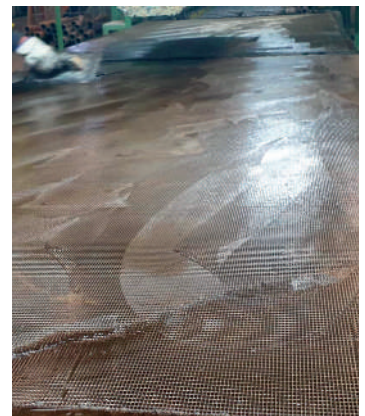



## PIGMENTO EN POLVO / POWDER PIGMENT

Pigmento para resinas de poliéster.

*Pigment for polyester resins.*

OPCIONES DISPONIBLES / AVAILABLE OPTIONS ▼

COLOR  
COLOUR

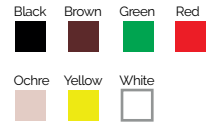

UNIDADES  
UNITS

1 L 

ref. 092406



## UNIVERSAL PIGMENT PASTE

Pigmentos en pasta universales para colorear pegamentos y masillas con base Poliester, Epoxi y Epoxi-Acrilato (Poliepo).



*Universal pigment paste for coloring adhesives and mastics based on Polyester, Epoxy and Epoxy-Acrylate (Poliepo).*

OPCIONES DISPONIBLES / AVAILABLE OPTIONS ▼

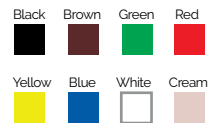
COLOR  
COLOUR



UNIDADES  
UNITS

125 gr   
1 Kg 

ref. 092304



# NO MEN CLA TURA

NOMENCLATURE





## FIJACIONES COUPLINGS

DX	Fijación Helicoidal a Derechas Helicoidal Coupling to the Right
M14	Fijación Métrica 14 / Metric 14 coupling
SP	Fijación Específico / Specific Coupling
VEL	Fijación Velcro / Velcro Coupling
TZ	Fijación Terzago / Terzago Coupling
5/8" 11F	Fijación 5/8" 11F / 5/8" 11F Coupling
5/8" 11F DX	Fijación Helicoidal a Derechas 5/8" 11F Helicoidal Coupling to the Right 5/8" 11F
FRANKFURT	Fijación Frankfurt / Frankfurt Coupling

## DUREZAS HARDNESS

GR	Granito / Granite
QZ	Quarzo / Quartz
CR	Cerámica / Ceramic
PAV	Pavimento / Floor
CON	Hormigón / Concrete
MR	Mármol / Marble
TR	Terrazo / Terrazzo
B	Blando / Soft
N	Normal / Normal
D	Duro / Hard
GR	Especial Granito / Special Granite









## APLICACIÓN ÚTILES TOOL APPLICATIONS

	Fregadora Scrubber
	Rotativa Swing
	Alta Velocidad High Speed
	Amoladora Grinder
	Satelitaria / Planetary Pavimentos / Floors
	Tradicional Traditional
	Fratasadora Trowel

## APLICACIÓN QUÍMICOS CHEMICAL APPLICATIONS

	Aplicación con brocha Brush application
	Aplicación con fregadora Application with scrubber
	Aplicación con máquina a presión Application with pressurized machine
	Aplicación con fregona Application with mop
	Aplicación con rotativa Application with swing
	Aplicación manual Manual application
	Aplicación con máquina automática Application with automatic machine
	Aplicación con atomizador Application with atomizer
	Aplicación con amoladora Application with grinder

## OTRAS ABREVIATURAS OTHER ABBREVIATIONS

	Limpieza Cleaning		Protección Protection		Mantenimiento Maintenance		Uso en seco Dry use
	Pegamentos Glues		Masillas Mastics		Resinas Resins		Uso en húmedo Wet use

## USO QUÍMICOS, PEGAMENTOS, MASILLAS Y RESINAS CHEMICALS, GLUES, MASTICS AND RESINS USE

	Especial para Pavimentos y Revestimientos Special for Coatings and Floors		Uso en interior y exterior Use for inside and outside		Protección rayos UV UV protect
	Especial para Pavimentos Special for Floors		Uso en exterior Use for outside		Material sólido Solid material
	Especial para Revestimientos Special for Coatings		Uso en interior Use for inside		Material sólido Solid material
	Tiempo de GEL GEL time		Tiempo de CURADO CURE time		Material líquido Liquid material
	Baja viscosidad Low viscosity		Muy líquido Extra liquid		Proporción Proportion
	Muy cristalino Extra crystal				

ADM	Abrasivo Diamantado Metálico / Diamond Metallic Abrasive
ADR	Abrasivo Diamantado Resinoide / Diamond Resined Abrasive
R.P.M.	Revoluciones por minuto / Revolutions per minute
NEUTRAL	Producto sin pigmentar / Product without pigmentation
CRYSTAL	Producto cristalino / Crystalline product
	Producto específico para curado por Radiación Ultravioleta Specific product for curing by Ultraviolet Radiation





**PRODUCTION CENTER 1**

**POSTAL ADDRESS**

P. I. Las Atalayas  
P.O. Box 20.002  
Avda. de La Antigua Peseta, 140  
03114 Alicante (Spain)

**PRODUCTION CENTER 2**

Elche Parque Empresarial  
C/ Manuel de Falla 5. 03203  
Elche (Spain)

**PRODUCTION CENTER 3**

Polígono Babel  
Calle de las Artes Gráficas, nº33  
03008 Alicante (Spain)

T. (+34) 965 112 713

[info@abrasivosalicante.com](mailto:info@abrasivosalicante.com)

[www.abrasivosalicante.com](http://www.abrasivosalicante.com)



**INNOVATION**

**PRODUCTION**

**ASSISTANCE**