

# Terrco<sup>®</sup>, Inc.

01-S Series



**OPERATING INSTRUCTIONS**

**MAINTENANCE INSTRUCTIONS**

**ILLUSTRATED PARTS LIST**

**Terrco<sup>®</sup>, Inc.**

222 1st Avenue NW • Watertown, SD 57201

Phone: (605) 882-3888 • Fax: (605) 882-0778 • Email: [info@terrco.com](mailto:info@terrco.com)

# Terrco<sup>®</sup> 01-S Series

HP/KW	7.5/5.6
SWEEP OF DISCS	27" (685,8 mm)
ABRASIVE PRESSURE	440 LBS (200 kg)
WIDTH OF MACHINE	27-1/4" (692 mm)
LENGTH OF MACHINE HANDLE UP	29-1/4" (743 mm)
LENGTH OF MACHINE HANDLE DOWN	56-1/2" (1435 mm)
HEIGHT OF MACHINE	37-1/2" (952,5 mm)
NET WEIGHT	800 lbs (363 kg)
SHIPPING WEIGHT	860 lbs (390 kg)
WATER TANK	7 gallon (26,5 L)
POWER CORD (8-3)	100 ft (30,5 m)

\* WEIGHT MEASURED WITH FOUR POCKET WEIGHTS

- Optimal for jobs under 5,000 sq. ft.
- Mild Steel or Stainless Steel Guards
- Stainless Steel Water Tanks
- Wet/Dry Setup
- Direct Drive, No Belts
- Leveling System
- Adjustable Handle
- Uses Plug Stone Shape, Bolt on to Universal Tool Plate, or Speed Shift System

## PRODUCTION RATES

- Mastic removal rate of 350 sq. ft. per hour
- Thin-Set removal rates of 400 sq. ft. per hour
- Thin-Mil coatings removal of 200 sq. ft. per hour
- Concrete polishing rates of 450 sq. ft. per polishing pad per hour (depending on grit)
- Rough Terrazzo rate of 600 sq. ft. per day

## ELECTRICAL OPTIONS

VOLTAGE	230	230	230	230	460
PHASE	1	1	3	3	3
DRIVE	MANUAL	VARIABLE	MANUAL	VARIABLE	VARIABLE
AMP DRAW	34	34	22	22	11
BREAKER (AMPS)	50	50	30	30	30
STONE HOLDER RPM	390	390-585	390	390-585	390-585

## Terrco<sup>®</sup>, Inc.

- 222 1ST AVE. NW
- WATERTOWN, SD 57201
- EMAIL: [info@terrco.com](mailto:info@terrco.com)
- PHONE: (605) 882-3888
- FAX: (605) 882-0778
- WEBSITE: [www.terrco.com](http://www.terrco.com)

---

## SAFTY PRECAUTIONS

---

This machine is intended for commercial use. It is designed exclusively to grind and polish Terrazzo and concrete floors. Use only recommended accessories and abrasives. When the machine is in need of repair, use only Terrco parts. All operators must read, understand and practice the following safety precautions.



WARNING: Rotating grinding wheels can cause injury, keep hands and loose clothing clear.



WARNING: Disconnect power at the machine before servicing or changing grinding stones.



WARNING: Always check ground (earth) connection prior to operating machine.

For Safety:





- 1: Have electrician hook up power to machine.
- 2: Always operate machine with ground fault protection.
- 3: Eye, hearing and respiratory protection advised.
- 4: Service and adjust guards for maximum protection. Never remove the guards.
- 5: Keep machine clean and properly serviced.

---

# SAFETY LABEL

---

The safety label is located on the machine as indicated below.  
Replace label if it is damaged or illegible.

 <b>WARNING</b> FOR SAFETY, READ OWNERS MANUAL BEFORE USING MACHINE	
	ROTATING CUTTERS KEEP GUARDS IN PLACE AND ADJUSTED KEEP HANDS AND FEET AWAY WHEN OPERATING
	WEAR EYE AND HEARING PROTECTION WHILE OPERATING THE MACHINE
	GRINDING CAN GENERATE DUST. DUST MAY AFFECT THE BREATHING FUNCTION. AVOID DUST CONTACT BY USE OF MASK OR RESIRATOR.
	DISCONNECT POWER AT THE MACHINE BEFORE SERVICING MACHINE OR CHANGING GRINDING STONES. ALWAYS CHECK GROUND (EARTH) PRIOR TO OPERATING MACHINE.



# Operating and Maintenance Instructions

## Introduction

This Manual has been prepared to assist you in the proper maintenance and operation of your Terrco<sup>®</sup> Machine. Please bear in mind that your 501-S or 701-S machine is a precise piece of machinery manufactured to exacting standards. In order for you to obtain maximum use of your machine, we suggest that you read this manual completely and thoroughly before attempting to operate your machine. A parts diagram and parts list are included to assist you in ordering the proper parts. Always give the machine number and model number when ordering your repair parts.

### I. Preliminary Procedures to Follow Before Operating Machine for the First Time

#### A. Delivery of Machine

1. On delivery the contractor should very carefully examine the shipping crate to see that it has not been mishandled. Before accepting the shipment, uncrate the machine and very carefully examine the machine to ensure that nothing has been damaged. If damage is noted, request an inspection immediately and request a copy of the claim report. When accepting the machine from the delivery carrier, note the damage on the bill of lading before signing.
2. **Terrco<sup>®</sup> will not** honor any claims for broken, damaged, or missing parts that may have occurred in shipping, as each machine is checked and inspected before leaving our plant.

B. The machine **has** been fully lubricated at the factory before shipping.

### II. On-The-Job Instructions

#### A. Installation Instructions—Stones

1. Remove the weights and raise adjustable handle as far forward as possible, lock into position and put one foot on the rubber-tired wheel.
2. Tip the machine back to the floor so that the handle lays on the floor.
3. Clean stone mounting surface.
4. **IMPORTANT!** Install the plug stones in the following manner. Place the stone firmly into the plug stone holder and twist.
5. After the stones are installed raise the machine until it is in operating position with all stones on the floor. Lower handle to position best suited for the operator, and replace the removable weights.
6. **CAUTION!** NEVER ATTEMPT TO START THE MACHINE WHILE LOWERING TO THE FLOOR, as the rear stones will strike on the corners resulting in thrown stones and possible damage to the machine.

#### B. Electrical and Plug-In Instructions

##### 1. General Instructions

- a. Always operate your machine with ground faults wired at the electrical source.
- b. Low voltage is a common occurrence on many terrazzo jobs, and hence it is necessary that the terrazzo contractor know his incoming voltage and amperage at the machine.

- c. As a result of the low voltage and the use of a 230 Volt motor, Terrco<sup>®</sup> has installed a booster box with pre-wired plugs already connected to your machine.
- d. If the machine is to operate on an area more than 100 feet from the electrical source it will be necessary to use the next lower number (larger) size cable from the source to the 100 foot wire cable that we furnished with the machine.
- e. If additional cable is necessary, be sure all connections are of the proper size and that they are tight.
- f. As a final step before starting the machine, we strongly recommend that a voltage reading is taken; this requires very little time and could save a great deal of trouble.

- b. One fitting on foot leveling device (Ref. number 86); recommended grease Mobilith AW-1 or equivalent every six months with 1/2 shot of grease.
- c. There are four shoulder bolts located at the pivot points of the handle bar that require 1/2 shot of Mobilith AW-1 or equivalent every six months.

### III. General Maintenance and Repair Instructions

#### A. The Lubrication of the Machine

1. The lubrication of the main gear case.
  - a. The main gear case contains 6-1/4 pounds of Mobilith AW-1 grease.
  - b. Gear case level should be checked once a year. The level of the grease in the gear case should be up to half the thickness so the helical gears (Ref. number 3 and 4 on the parts diagram).
2. The lubrication of the wheel bearings.
  - a. Use grease gun and grease every six months with 1 shot of grease, (fitting Ref. number 96 on the parts diagram) on each wheel with Mobilith AW-1 or equivalent.
3. Location of other Grease Fittings
  - a. Two fittings on bearing caps on top of gear case (Ref. number 86). Lubricate these fittings with Mobilith AW-1 every six months with 3 shots of grease

#### B. Keeping Machine Clean

1. Schedule daily cleaning after each days grinding.
  - a. Tilt machine back on handle
  - b. Clean under carriage with water using a garden hose and nozzle.
  - c. Clean all grease fittings.
2. Do not let any cake-up of cement grinding paste occur as this could create an overload on your machine.

#### C. Replacements of worn, Damaged, or Missing Parts

1. Advantages
  - a. If worn parts (bearings, gears, etc) are not replaced promptly, serious damage to your machine could occur.
  - b. Your machine will operate more efficiently with new Terrco<sup>®</sup> parts.
2. Use only authorized Terrco<sup>®</sup> parts as our warranty will not apply if other than factory authorized Terrco<sup>®</sup> parts are used.

#### D. Morflex Flexible Couplings

1. Bolts, (Ref. number 87) should be checked weekly for tightness. Loose bolts cause extreme vibrations and premature failure of rubber inserts in the couplings.
2. Your flexible couplings (Ref. number 37) should be changed a minimum of once a year whether you use your machine or not.

## E. High Motor Temperature

### 1. Introduction

- a. "Running Hot" is normal for the smaller, lighter "t" type motor.
- b. Even though they will run hotter, the "T" motors run more efficiently.
- c. We as human beings, cannot stand a temperature on our skin over 135° Fahrenheit, yet, most electric motors on Terrco<sup>®</sup> machines are designed to operate efficiently at 165° .

### 2. Operating Characteristics

- a. The temperatures of motors are rated by temperature rise and full load over and above room temperature (25°C or 77°F)
- b. To convert degree Centigrade to degree Fahrenheit, multiply degree Centigrade by the fraction 9/5 and add 32.
- c. Older (repulsive-induction) type motors were rated 40° Centigrade rise, or approximately 150° Fahrenheit.

### 3. Conclusion

- a. It is recommended that you keep you hands off the motors when they are hot.
- b. If you desire to know the temperature of the motor do the following:
  - (1). Place a 200°F thermometer on the frame of the motor
  - (2). Place a glob of putty over the bulb of the thermometer.
  - (3). Take the temperature readings.
- c. Also, do not forget we use a thermal protected starter on Terrco<sup>®</sup> machines, and this protects the motor against low voltage and overload conditions which might raise the temperature of the motor beyond safe limits.

## F. Stone Wear and Replacement

1. Check your stones for wear periodically, as the stones may be worn flush with stone holder lugs and the operator may be grinding with steel stone spiders.

## IV. Exclusive Features of the 01-S Series

### A. Advantages of "T" Type Motor Design

1. Less amperage draw.
  - a. 15% less in the 5 HP size.
  - b. 9-1/2% less in the 7-1/2 HP size.
2. Higher safe operating temperature (165°F)
3. Lightweight.
  - a. 42-1/2% less in the 5 HP size.
  - b. 34-1/2% less in the 7-1/2 HP size.
4. Less maintenance.
  - a. No brushes.
  - b. Less internal wiring.

### B. Advantages of New Manual Foot Leveling Device

1. Improved machine control.
2. Faster and greater range of adjustments.
  - a. Six leveling adjustments.
  - b. 1/8" increments
3. Simple to operate by merely pushing down on foot lever and raising up on handle.

### C. Lightweight machine for ease of transportation and yet has sufficient abrasive pressure by use of the removable weights.

## D. Ten Position Handle

### 1. Advantages.

- a. Easier to “break” machine when changing stones.
  - (1). After removing the weighs, unscrew safety knob (Ref. number 107), push knob (Ref. number 18) to the rear to release the locking mechanism. Raise handle two or three notches, lock handle by reversing the above procedure and tilt stone holders off the floor.
  - (2). Pushing the handle forward two or three notches creates a safe stone position for changing, as the machine will not have a tendency to “flip-up”. It also makes it much easier to get at the stone changing area.

### 2. Operation

- a. The adjustable handle is very easy to operate. You merely unscrew the safety knob (Ref. number 107), push knob (Ref. number 18) to the rear to release the locking mechanism. When you have raised or lowered the handle to your desired position, push knob (Ref. number 18) forward as far as you can and screw the safety knob (Ref. number 107) tight. This will lock the handle in position.
- b. Make sure that you have pulled knob (Ref. number 18) **completely** to the rear to assure full unlocking of mechanism and the safety knob (Ref. number 107), is screwed up tight.

## Maintenance Chart

Part #	Date	Checked By	Areas of Concern



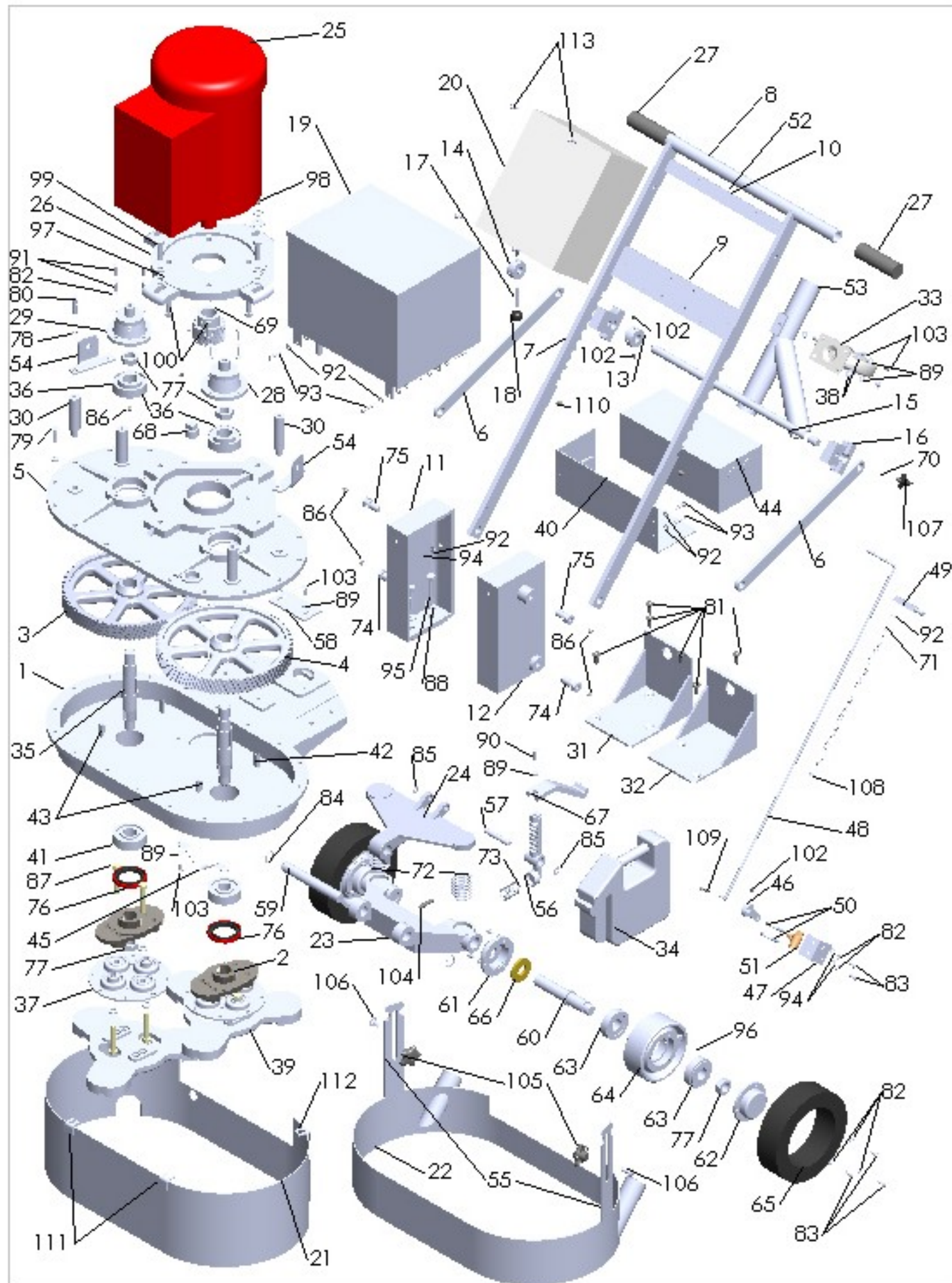

# 01-S Series Parts List

ITEM NO.	PART NUMBER	DESCRIPTION	QTY.	ITEM NO.	PART NUMBER	DESCRIPTION	QTY.
1	LW 001	GEAR CASE	1	33	LW 084	CASTER WHEEL	1
2	SM 500	DRIVE SPIDER	2	34	FE 246	POCKET WEIGHT	4
3	SM 015L	HELICAL GEAR LH	1	35	SM 016	HELICAL GEAR SHAFT	2
4	SM 015R	HELICAL GEAR RH	1	36	SM 036, SM 037	BEARING CONE, BEARING CAP	2
5	LW 002	GEAR CASE COVER	1	37	SM 088	MORFLEX COUPLING	2
6	LW 015	STOP SLIDE BAR	2	38	T2148	FLAT WASHER	4
7	LW 016C	HANDLE BAR SLOTTED RAIL	2	39	SM 491A	SPEED SHIFT TOOL PLATE	2
8	LW 017	HANDLE BAR TUBE	1		SM 192B	PLUG STONE TOOL PLATE	2
9	LW 019	LOWER SWITCH BOX BRACKET	1		SM 492-SP	UNIVERSAL TOOL PLATE	2
10	LW 020	UPPER SWITCH BOX BRACKET	1	40	LW 087	BOOSTER BOX HOLDER	1
11	LW 061	HANDLE BRACKET RH	1	41	SM 043, SM 037	BEARING CONE, BEARING CAP	2
12	LW 006A	HANDLE BRACKET LH	1	42	SM 072	HELICAL GEAR KEY	2
13	LW 014	INDEXING STOP	1	43	T 2012	WOODRUFF KEY	2
14	LW 032	COLLAR	1	44	X 048	TRANSFORMER	1
15	LW 070	POSITIONING ROD	1	45	SM 172	WATER HOSE BRACKET	1
16	LW 009D	HANDLE SLIDE BLOCK	2	46	LW 010	WATER VALVE LEVER	1
17	LW 031	STUD	1	47	LW 012	MOUNTING CLAMP	1
18	LW 033	PLASTIC KNOB	1	48	LW 018	WATER TANK LEVER	1
19	LW 008-SS	WATER TANK-STAINLESS	1	49	LW 029	HANDLE GUIDE	1
20	SM 091-ENCLOSURE	MAGNETIC STARTER	1	50	LW 11	WATER VALVE CLAMP	2
	FE 278	VARIABLE SPEED DRIVE	1	51	SM 174	WATER TANK VALVE	1
21	SMN 035	STATIONARY GUARD-MILD	1	52	T2003	HEX NUT	4
	SMN 035-SS	STATIONARY GUARD-STAINLESS	1	53	SM 457	Y-PIPE (DRY ONLY)	1
22	SM 442	DRY GUARD ASSEMBLY	1	54	SM 535	GUARD BRACKET	2
23	SM 320	LOWER CARRIAGE BRACKET	1	55	SM 536	GUARD STRAP	2
24	SM 319	UPPER CARRIAGE BRACKET	1	56	SM 322	FOOT PEDAL ARM	1
25	SM 349	7.5 HP, 1 PH, 230 V, 60 Hz MOTOR	1	57	SM 329	PIN	1
	SM 349A	7.5 HP, 3 PH, 240/415 V, 50 Hz	1	58	SM 328A	CARRIAGE PLATE	1
	SM 349B	7.5 HP, 3 PH, 230 V, 60 Hz	1	59	SM 327	PIN	1
	SM 349C	7.5 HP, 1 PH, 230 V, 50 Hz	1	60	SM 011B	TRUCK WHEEL SHAFT	2
	LW 055	5 HP, 1 PH, 220 V, 50Hz	1	61	SM 010	INNER BAERING CAP	2
26	SM 263	MOUNTING PLATE	1	62	SM 009	OUTER BEARING CAP	2
27	SM 057	HANDLE GRIP	2	63	SM 069, SM 070	BEARING CUP, BEARING CONE	4
28	LW 023R	BEARING CAP-RH	1	64	SM 008	TRUCK WHEEL	2
29	LW 023L	BEARING CAP-LH	1	65	SM 068	TRUCK WHEEL TIRE	2
30	SM 482	RISER PIN	4	66	SM 012	TRUCK WHEEL FELT WASHER	2
31	FE 248L	WEIGHT BASKET-LH	1	67	SM 323	FOOT PEDAL	1
32	FE 248R	WEIGHT BASKER-RH	1	68	T 2011	GREASE PLUG	1

ITEM NO.	PART NUMBER	DESCRIPTION	QTY.	ITEM NO.	PART NUMBER	DESCRIPTION	QTY.
69	SM 214	7.5 HP PINION	1	91	T2018	CAPSCREW	8
	LW 028	5 HP PINION	1	92	T2054	FLAT WASHER	15
70	LW 024	LOCK COLLAR	3	93	T2014	CAPSCREW	7
71	SM 182	COMPRESSION SPRING	1	94	T2003	HEX NUT	9
72	SM 326	UNDER CARRIAGE SPRING	2	95	T1024	CAPSCREW	4
73	SM 325	UNDER CARRIAGE SPRING	1	96	AH 026	GREASE ZERK	2
74	HBS 145B	SHOULDER BOLT	2	97	T2149	WROUGHT FLAT WASHER	4
75	LW 027A	SHOULDER BOLT	2	98	T2021	CAPSCREW	1
76	SM 169	GREASE SEAL	1	99	T2006	CAPSCREW	3
77	T2008	NYLON LOCK NUT	6	100	T1009	CAPSCREW	4
78	T1022	LOCK WASHER	2	101	T2057	SET SCREW	1
79	T1025	CAPSCREW	1	102	T3007	SET SCREW	3
80	T2004	CAPSCREW	8	103	T2130	CAPSCREW	9
81	T2116	SOCKET FLAT HEAD	6	104	T1055	SET SCREW	1
82	T1030	LOCK WASHER	22	105	SM 537	GUARD KNOB	2
83	AH 017	FILLISTER HEAD	14	106	T2029	CARRIAGE BOLT	2
84	SM 331	SNAP RING	2	107	HBS 196	HANDLE BAR KNOB	1
85	SM 230	SNAP RING	2	108	SM 186	HANDLE SPACER COLLAR	1
86	170	GREASE ZERK	7	109	T2082	COTTER PIN	1
87	SM 171	CAPSCREW	8	110	LW 064	DOWEL PIN	2
88	T1012	LOCK WASHER	16	111	SM 028	GUARD BRACKET	2
89	T1007	LOCK WASHER	10	112	SM 028L	LONG GUARD BRACKET	2
90	T1006	CAPSCREW	1	113	FE 098	SLOTTED TRUSS HEAD SCREW	4

## NOT PICTURED

PART NUMBER	DESCRIPTION	QTY.
SM 195	10-3 CABLE (501-S)	100'
T2145	8-3 CABLE (701-S)	100'
SM 206	MALE PLUG, 30A, 1 PH (501-S)	2
SM 207	CONNECTOR, 30A, 1 PH (501-S)	2
SM 420	MALE PLUG, 50A, 1 PH (701-S)	2
SM 421	FEMALE PLUG, 50A, 1 PH (701-S)	2
SM 424	MALE PLUG, 50A, 3 PH (701-S)	2
SM 425	FEMALE PLUG, 50A, 3 PH (701-S)	2
FE 207	VACUUM HOSE	
LW 078	BRUSH STRIP	
SM 456	DUST SEAL	1
LW 076	EMERGENCY STOP	1
SM 091-BUTTON	START/STOP (MAGNETIC ONLY)	1

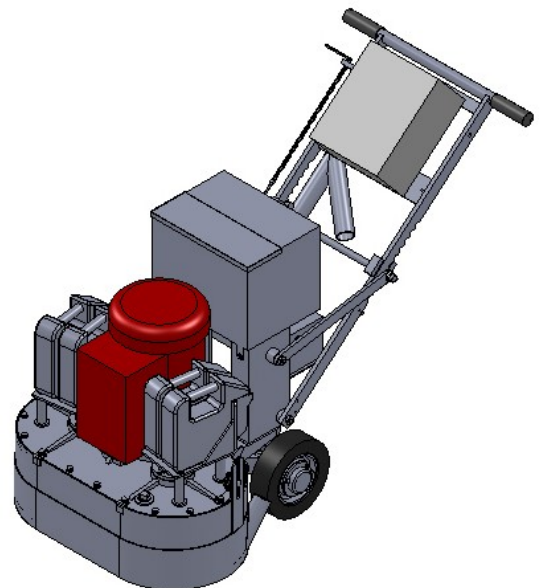

## **WARRANTY CLAIM PROCEDURE**

Each new machine is covered by two separate, distinct warranties—one on the machine and one on the electric motor of gasoline engine. Read VERY CAREFULLY the Terrco<sup>®</sup> warranty covering the machine, as this will tell you whether you have a warranty claim or not. If your machine is under warranty and malfunctions, determine whether your problem is electrical or mechanical, and do the following:

### **I. Electrical.**

- A. Consult the list of authorized motor repair stations sent with the machine and locate the station nearest you.
- B. Contact the repair station, giving them the following information:
  - 1. Complete nameplate data from the motor.
  - 2. Tell them that the machine is a terrazzo grinding and polishing machine.
  - 3. Give them a description or rundown of the trouble.
  - 4. Inform them of the voltage and amperage readings as outlined in paragraph II, B, 2 and 3, on page 2 of this manual.

### **II. Mechanical**

- A. Contact your Terrco<sup>®</sup> Distributor giving them the following:
  - 1. Model and date purchased.
  - 2. Horsepower.
  - 3. Accurate description of the malfunction.
- B. If there is no Terrco<sup>®</sup> Distributor in your area call or write to us with the above information.

## **LIMITED ONE YEAR WARRANTY**

TERRCO<sup>®</sup> Inc. warrants the original purchaser of the Terrco<sup>®</sup> grinding equipment to be free from defects in materials and workmanship under normal use and service. Our obligation under this warranty shall be limited to the repair or exchange of any part or parts which may prove defective under normal use and service within one year from date of purchase by, the original purchaser, and which our examination shall disclose to our satisfaction to be defective.

All equipment returned for repairs or exchange must be returned to: TERRCO<sup>®</sup>, Inc., at the purchaser's expense and within the warranty period. All repaired or exchanged equipment will be shipped back to the purchaser F.O.B. Watertown, South Dakota.

THIS WARRANTY IS EXPRESSLY IN LIEU OF ALL OTHER WARRANTIES EXPRESSED OR IMPLIED INCLUDING THE WARRANTIES OR MERCHANTABILITY AND FITNESS FOR USE AND ALL OTHER OBLIGATIONS OR LIABILITIES ON THE PART OF TERRCO<sup>®</sup>, INC. AND WE NEITHER ASSUME OR AUTHORIZE ANY OTHER PERSON TO ASSUME FOR US, ANY OTHER LIABILITY IN CONNECTION WITH THE SALE OF THIS EQUIPMENT. SOME STATES DO NOT ALLOW THE EXCLUSIONS OR LIMITATIONS ON IMPLIED WARRANTIES OR DO NOT ALLOW THE EXCLUSION OF LIMITATION OF INCIDENTAL OR CONSEQUENTIAL DAMAGES, SO THE ABOVE EXCLUSIONS OR LIMITATIONS MAY NOT APPLY TO YOU. THIS WARRANTY SHALL NOT APPLY TO ANY EQUIPMENT OR PART THEREOF WHICH HAS BEEN SUBJECT TO ACCIDENT, NEGLIGENCE, ALTERATIONS, ABUSE, MISUSE, OR IMPROPER MAINTENANCE. TERRCO<sup>®</sup>, INC. MAKES NO WARRANTIES WHATSOEVER IN RESPECT TO ACCESSORIES OR PARTS NOT MANUFACTURED OR SUPPLIED BY US.